

# 2011

SUPER DUTY®  
CHASSIS CAB

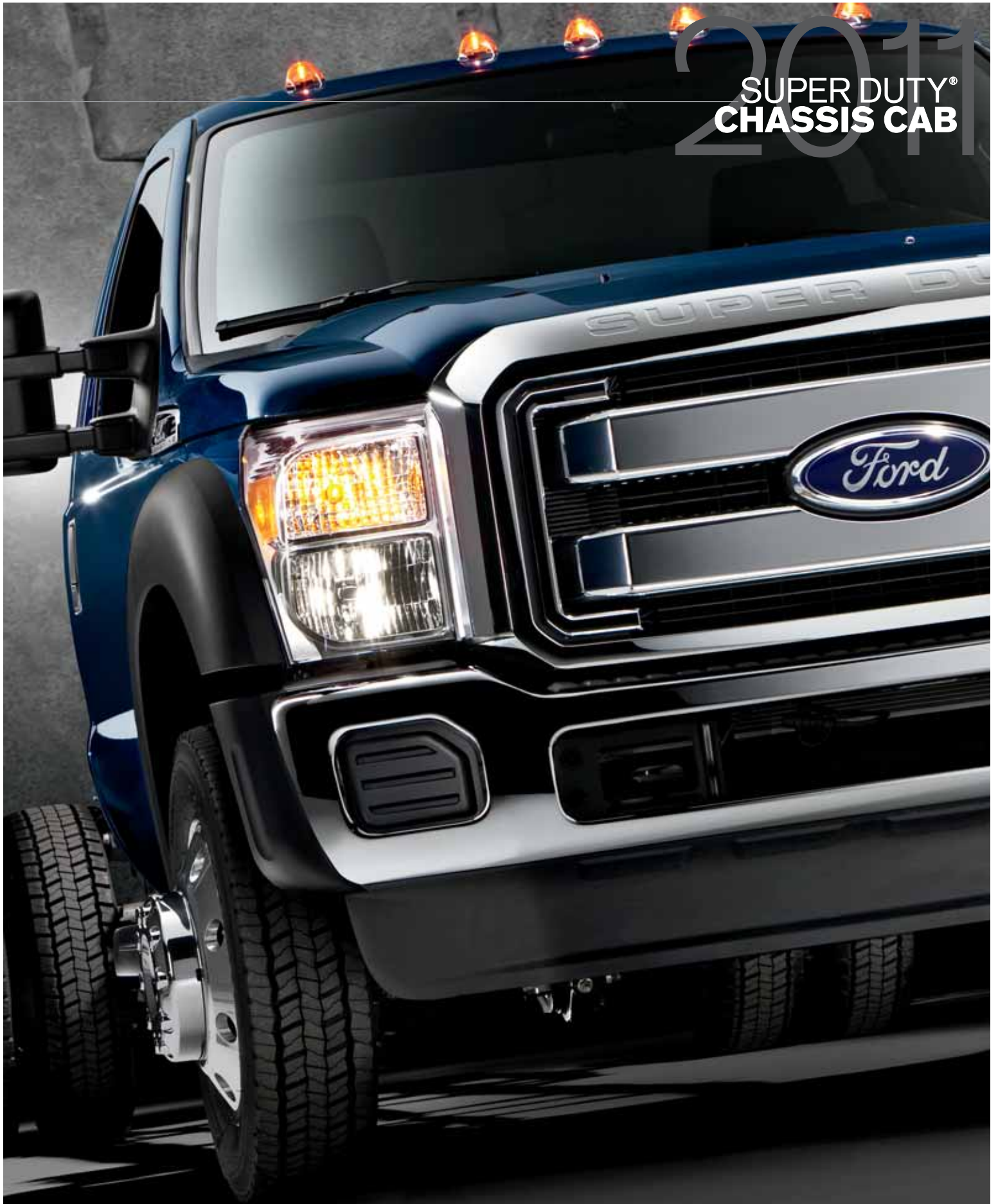

Specifications

[commtruck.ford.com](http://commtruck.ford.com)



## MODELS

### F-350

#### MAXIMUM CAPABILITIES<sup>1</sup>

5th-Wheel Towing: 16,500 lbs.

Conventional Towing: 15,000 lbs.

Payload: 7,522 lbs.

GCWR: 24,500 lbs.

GVWR: 13,000 lbs.

Front GAWR: 5,250 lbs. (4x2); 6,000 lbs. (4x4)

#### EQUIPMENT CONFIGURATIONS

Engines: 6.2L Gas V8 Flex Fuel E85-capable  
6.7L Power Stroke® V8 Turbo Diesel B20-capable

Drivelines: 4x2 or 4x4 ■ Single Rear Wheel or Dual Rear Wheel

Bodies: Regular Cab, SuperCab, Crew Cab

Trim Series: XL, XLT, LARIAT

### F-450

#### MAXIMUM CAPABILITIES<sup>1</sup>

5th-Wheel Towing: 21,500 lbs.

Conventional Towing: 16,000 lbs.

Payload: 9,976 lbs.

GCWR: 30,000 lbs.

GVWR: 16,500 lbs.

Front GAWR: 7,000 lbs.

#### EQUIPMENT CONFIGURATIONS

Engines: 6.8L Gas V10  
6.7L Power Stroke V8 Turbo Diesel B20-capable

Drivelines: 4x2 or 4x4 ■ Dual Rear Wheel Only

Bodies: Regular Cab, SuperCab, Crew Cab

Trim Series: XL, XLT, LARIAT

### F-550

#### MAXIMUM CAPABILITIES<sup>1</sup>

5th-Wheel Towing: 26,500 lbs.

Conventional Towing: 16,000 lbs.

Payload: 12,761 lbs.

GCWR: 35,000 lbs.

GVWR: 19,500 lbs.

Front GAWR: 7,000 lbs.

#### EQUIPMENT CONFIGURATIONS

Engines: 6.8L Gas V10  
6.7L Power Stroke V8 Turbo Diesel B20-capable

Drivelines: 4x2 or 4x4 ■ Dual Rear Wheel Only

Bodies: Regular Cab, SuperCab, Crew Cab

Trim Series: XL, XLT, LARIAT

### PICKUP BOX DELETE

Available on F-250 and F-350 Pickups with long wheelbases only. Includes 16K trailer hitch receiver (trailer tow rating limited to 12.5K lbs.). Deletes pickup box, tie-down hooks, bodyside moldings, rear bumper, spare wheel, tire, carrier and jack.

## STANDARD FEATURES

#### MECHANICAL

90,000-mile tune-up interval<sup>2</sup> (gas engines)

Auxiliary rear springs

Battery saver

Brakes – Hydro-boost (SRW diesel and all DRW)

Brakes – Vacuum-boost (SRW gas)

Engine-only traction control (EOTC) (DRW only)

Fail-Safe Engine Cooling System (gas engines)

Front and rear stabilizer bar

Fuel tank – 28-gallon midship (SRW)

Fuel tank – 40-gallon aft-of-axle (DRW)

Power steering

Stainless steel exhaust system (major components)

Stationary Elevated Idle Control (SEIC)<sup>3</sup>

Steering damper

Trailer sway control (SRW only)

Trailer tow prep includes 7-wire harness (blunt cut) with relays

#### INTERIOR

Assist and ride handles

Coat hooks – 1 (Regular Cab); 2 in rear of cab (SuperCab and Crew Cab)

Dome light (front and rear with Crew Cab)

Flip-open rear quarter windows (SuperCab)

Overhead console with garage door opener storage and sunglasses storage (SuperCab and Crew Cab)

Powerpoints located on instrument panel (2)

Tilting/telescoping steering column

Upfitter switches located on instrument panel (4)

#### EXTERIOR

“3-Blink” lane change signal

Dual-beam jewel-effect headlamps

Front step bumper

Front tow hooks (2)

Roof clearance lamps

Solar-tinted glass

Underhood service lamp

Windshield wipers – Intermittent

#### SAFETY & SECURITY

4-wheel power disc brakes with Anti-Lock Brake System (ABS)

AdvanceTrac® with RSC® (Roll Stability Control™) (SRW only)

Belt-Minder® front safety belt reminder

Brake/shift interlock

Child-safety-seat top tether anchors (Regular Cab front passenger and all rear-seat positions)

Driver and right-front-passenger front airbags<sup>4</sup>

Front-seat side airbags<sup>4</sup>

Fuel pump inertia shutoff switch

Headlamps-on, key-in-ignition and door ajar alert chimes

Height-adjustable safety belts at front-outboard positions

Passenger airbag deactivation switch (Regular Cab, SuperCab)

Safety belt energy-management retractors at front-outboard positions

Safety Canopy® System with side-curtain airbags<sup>4</sup>

for all rows and rollover sensor

Side-intrusion door beams

SOS Post-Crash Alert System™

## OPTIONAL PACKAGES

16,000-lb. GVWR Package (F-450 only)

Ambulance Prep Package (Fleet only) includes dual alternators (combined 357 amps), standard-width axle with F-350 SRW, and wide-track limited-slip axle with F-350 DRW (restrictions apply)

Extra-Heavy-Service Front Suspension Package includes 2-up front springs upgrade (unless maximum springs have been computer selected as included equipment; restrictions apply)

Heavy-Service Front Suspension Package includes 1-up front springs upgrade (unless maximum springs have been computer selected as included equipment; restrictions apply)

High-Capacity Trailer Tow Package (F-450/F-550 only) includes 30,000-lb. GCWR for F-450 and 35,000-lb. GCWR for F-550 and upgraded rear-axle gear set (trailer brake controller not included; restrictions apply)

Low Deflection Package (F-450/F-550 only) includes 2-in. spacer blocks; recommended for rear-biased loading (restrictions apply)

Payload Downgrade Package (F-450/F-550 only) includes a 15,000-lb. GVWR rating for F-450 and a 17,500-lb. GVWR rating for F-550

Payload Upgrade Package (F-350 SRW only) increases GVWR for increased payload range (requires 18-in. wheels and tires)

Payload Upgrade Package (F-550 with 141-in. WB; requires 6.8L engine and 4.88 limited-slip rear axle) increases GVWR to 19,000 lbs. and includes upgraded frame and rear axle

Payload Plus Upgrade Package (F-550 only) increases GVWR to 19,500 lbs. and includes upgraded frame, rear axle and springs (restrictions apply)

Snow Plow Prep Package includes computer-selected springs for snow plow application and extra-heavy-duty alternator with diesel engine only (restrictions apply)

Trailer Tow Package includes aftermarket trailer brake wiring kit (trailer brake controller not included; restrictions apply)

<sup>1</sup>When properly equipped. <sup>2</sup>Under normal driving conditions with routine fluid and filter changes. <sup>3</sup>Final-stage manufacturer must supply control switches.

<sup>4</sup>Always wear your safety belt and follow airbag warning label instructions. Passenger airbag may be deleted.



# STANDARD FEATURES



## XL

Includes all standard features, plus:

### MECHANICAL

6.2L SOHC 2-valve Gas V8 Flex Fuel E85-capable engine (F-350)
6.8L SOHC 3-valve Gas V10 engine (F-450/F-550)
TorqShift® Heavy-Duty 6-speed SelectShift Automatic™ transmission (F-350)
TorqShift 5-speed automatic transmission (F-450/F-550)
17-in. <i>argent</i> -painted steel wheels (F-350)
LT245/75R17 all-season BSW tires (F-350)
19.5-in. <i>argent</i> -painted steel wheels (F-450/F-550)
225/70R19.5G all-season BSW tires (F-450/F-550)
Manual 4-Wheel-Drive System with manual locking hubs (4x4 models only)

### SEATING

HD vinyl 40/20/40 split front seat with armrest, cupholders and storage
60/40 split flip-up rear bench seat (SuperCab only)
60/40 flip-up/fold-down rear bench seat with outboard and center head restraints (Crew Cab only)
Manual lumbar support for driver seat

### INTERIOR

AM/FM stereo with digital clock and 2 speakers
Black urethane steering wheel
Black vinyl floor covering
Manual air conditioning
Manual day/night rearview mirror
Manual door locks and windows
Multifunction message center plus trip computer includes 3-button steering wheel switch, odometer, trip odometer, engine-hour meter, distance to empty, average fuel economy, oil-life monitor, warning messages, system check, language selection and Ice Blue™ lighting
Visors with passenger mirror

### EXTERIOR

Black bar-style grille
Black door handles
Black-painted front bumper with grained top cover
Manually telescoping trailer tow mirrors with 2-way fold and manual glass

**New Vehicle Limited Warranty.** We want your Ford F-Series Super Duty® Chassis Cab ownership experience to be the best it can be. So under this warranty, your new vehicle comes with 3-year/36,000-mile bumper-to-bumper coverage, 5-year/60,000-mile Powertrain Warranty coverage, 5-year/50,000-mile safety restraint coverage, and 5-year/unlimited-mile corrosion (perforation) coverage – all with no deductible. The Power Stroke diesel engine gets 5-year/100,000-mile Warranty Coverage. Please ask your Ford Dealer for a copy of this limited warranty.

**Roadside Assistance.** Covers your vehicle for 5 years or 60,000 miles, so you have the security of knowing that help may be only a phone call away should you run out of fuel, lock yourself out of the vehicle, or need towing. Your Ford Dealer can provide complete details on all of these advantages.

**Business Preferred Network.** Each of the select dealerships in our Business Preferred Network (BPN) is committed to providing quality commercial-oriented products and service, as well as special financing and billing arrangements, to businesses that rely on Ford products. As a BPN customer, your business vehicles receive priority service at your BPN dealership to help get your vehicle back on the road quickly.

**Financial Services.** Our commercial purchase plans and lines of credit offer attractive rates, negotiable terms and business-friendly options. If you prefer to lease, our CommercialLeaseSM programs offer a wide variety of package options to meet your needs. For additional information, please visit our website at [fordcredit.com/comlend/](http://fordcredit.com/comlend/).

**Ford Extended Service Plan.** For a purchase or lease, the Ford Extended Service Plan (ESP) gives you "Peace-of-Mind" protection designed to cover key vehicle components and protect you from the cost of unexpected repairs. Ask your dealer for a Ford ESP, the only service contract backed exclusively by Ford and honored at all Ford dealerships.



## XLT

Includes select XL features, plus:

### MECHANICAL

Integrated trailer brake controller
17-in. 5-spoke cast-aluminum wheels (F-350 SRW)

### SEATING

40/20/40 split front seat with center under-seat lockable storage with 12-volt powerpoint and center armrest with cupholders and storage
60/40 split flip-up/fold-down rear bench seat with bag hooks, dual integrated cupholders and tray, outboard head restraints, center head restraint and under-seat partitioned lockable storage with 12-volt powerpoint (Crew Cab only)

### INTERIOR

Accessory delay for power features
AM/FM stereo/single-CD player with MP3 capability, digital clock and 4 speakers
Auxiliary audio input jack
Color-coordinated floor covering (carpet)
Color-coordinated floor mats (carpet)
Cruise control
MyKey® owner controls feature
Power door locks
Power windows with one-touch-down driver's side window feature
Visors with covered driver and passenger mirrors

### EXTERIOR

Chrome bar-style grille
Chrome front bumper with grained top cover
Manually telescoping trailer tow mirrors with 2-way fold, power/heated glass, heated manual spotter mirrors, and integrated clearance lamps and turn signals
Perimeter anti-theft alarm
Privacy glass (rear doors and rear window)
Remote Keyless Entry System with 2 integrated keyhead transmitter remotes



## LARIAT

Includes select XLT features, plus:

### MECHANICAL

6.7L Power Stroke® V8 Turbo Diesel B20-capable engine (F-450/F-550)
TorqShift Heavy-Duty 6-speed SelectShift Automatic transmission (F-450/F-550)
Electronic Shift-On-the-Fly (ESOF) 4-Wheel-Drive System with auto/manual locking hubs (4x4 models only)
18-in. 6-spoke cast-aluminum wheels (F-350 SRW)
17-in. forged polished-aluminum wheels (F-350 DRW)
19.5-in. forged polished-aluminum wheels (F-450/F-550)

### SEATING

Premium leather-trimmed 40/console/40 front bucket seats and flow-through center console with lockable storage, two 12-volt powerpoints and a 110-volt power inverter
Power 10-way driver and front-passenger seats

### INTERIOR

Auto-dimming rearview mirror with compass
Color-coordinated leather-wrapped steering wheel with secondary audio controls
Driver-configurable enhanced information center with 4.2-in. LCD productivity screen includes gauge setup, trip computer, fuel economy and towing/off-road applications, SelectShift controls, halo lighting, daytime illumination, and 5-button steering wheel-mounted switch
Dual-zone electronic automatic temperature control
Ford SYNC® voice-activated, in-vehicle connectivity system
Premium Sound System AM/FM stereo/single-CD player with MP3 capability, digital clock and 8 speakers with subwoofer
Sirius Satellite Radio with 6-month trial subscription
Visors with illuminated driver and passenger mirrors
Woodgrain-style instrument panel accents

### EXTERIOR

Autolamp with rainlamp feature
Body-color door handles
Fog lamps
Power-sliding rear window with privacy glass
PowerScope™ power-telescoping/-folding trailer tow mirrors with power/heated glass, heated manual spotter mirrors, and integrated clearance lamps and turn signals
SecuriCode™ keyless entry keypad

Comparisons based on 2010 competitive models (class is Chassis Cab trucks under 22,000 lbs. GVWR), publicly available information and Ford certification data at time of release. Some features discussed may be optional. Vehicles shown may contain optional and aftermarket upfit equipment. Features shown may be offered only in combination with other options or subject to additional ordering requirements or limitations. Dimensions and capability ratings shown may vary due to optional features and/or production variability. Following release of the PDF, certain changes in standard equipment, options and the like, or product delays may have occurred which would not be included in these pages. Your Ford Dealer is the best source for up-to-date information. Ford Division reserves the right to change product specifications at any time without incurring obligations. Body manufacturers are responsible for compliance certification of the completed vehicle. The Ford New Vehicle Limited Warranty and any government certification made by Ford shall cover only the vehicle as manufactured by Ford and shall not extend to any addition, modification or change of or to the vehicle by the Ford Authorized Pool Account.

Garmin is a registered trademark of Garmin Ltd.

Windows is a registered trademark of Microsoft Corporation.

Microlise is a registered trademark of Microlise Limited.

Sirius is a registered trademark of Sirius XM Radio Inc. Subscriptions governed by Sirius Terms and Conditions at [sirius.com/serviceterms](http://sirius.com/serviceterms). Service available in the 48 contiguous states and D.C.

© 2010 Ford Motor Company 11FCCJ2WEBPDFSPEP

2011 SUPER DUTY® CHASSIS CAB  
Specifications

[commtruck.ford.com](http://commtruck.ford.com)



# XL



17-in. Argent-Painted Steel  
Standard on F-350 SRW



17-in. Argent-Painted Steel  
Standard on F-350 DRW



17-in. 5-Spoke Cast-Aluminum  
Optional on F-350 SRW



17-in. Forged Polished-Aluminum  
Optional on F-350 DRW



18-in. Argent-Painted Steel  
Optional on F-350 SRW



19.5-in. Argent-Painted Steel  
Standard on F-450/F-550 DRW



XL Crew Cab in Steel HD Vinyl with 40/20/40 split front seat



F-450 XL Regular Cab 4x4 in Oxford White with available and aftermarket equipment

# 2011 SUPER DUTY® CHASSIS CAB

Specifications

[commtruck.ford.com](http://commtruck.ford.com)



# XL OPTIONAL FEATURES

## MECHANICAL

6.7L Power Stroke® V8 Turbo Diesel B20-capable engine  
 Electronic Shift-On-the-Fly (ESOF) 4-Wheel-Drive System with auto/manual locking hubs (4x4 models only; n/a with 6.8L gas engine)  
 17-in. 5-spoke cast-aluminum wheels (F-350 SRW)  
 17-in. forged polished-aluminum wheels with bright hub covers – 4 (F-350 DRW)  
 18-in. argent-painted steel wheels – 4 (F-350 SRW)  
 Stainless steel wheel covers<sup>1</sup> (requires 17-in. argent-painted steel DRW wheels or 19.5-in. argent-painted steel wheels)  
 LT245/75R17 all-terrain BSW tires – 6 (F-350 SRW or DRW)  
 LT275/65R18 all-season BSW tires – 4 (F-350 SRW)  
 LT275/70R18E all-terrain BSW tires – 4 (F-350 SRW 4x4 only)  
 225/70R19.5G BSW traction tires – 2 all-season tires and 4 traction tires (F-450/F-550)  
 225/70R19.5G max traction BSW tires – 6 (F-450/F-550 4x4 only)  
 CNG/LPG-fuel capable engine (F-450/F-550 only)  
 Dual alternators with 357-amp total (diesel engine only)  
 Engine block heater (standard in 15 cold-weather states)  
 Fuel tank – 28-gallon midship (n/a w/189-in. WB Regular Cab or 200-in. WB Crew Cab with gas engines)  
 Fuel tank – Dual tanks (40-gallon aft-of-axle and 28-gallon midship; DRW diesel engine only; n/a with SYNC or in-dash computer)  
 Hydraulic jack (2-ton for F-350 SRW; 4-ton for F-350 DRW; 6-ton for F-450/F-550)  
 Integrated trailer brake controller  
 Operator-commanded regeneration (diesel engine only)  
 Power takeoff (PTO) provision (6.8L gas and 6.7L diesel engines only; includes transmission-mounted live drive and stationary modes with diesel engine only)  
 Rear axle – Electronic-locking (F-350 SRW only)  
 Rear axle – Higher-ratio (F-350 only)  
 Rear axle – Limited-slip (DRW only)  
 Spare tire/wheel/jack

## SEATING

40/mini-console/40 front bucket seats (HD vinyl or cloth)

## INTERIOR

Air conditioning delete (Fleet only)  
 AM/FM stereo/single-CD player with MP3 capability, digital clock and 4 speakers (Fleet only option; included with the XL Value Package)  
 Auxiliary audio input jack (requires CD player)  
 Cruise control (Fleet only)  
 Ford SYNC® voice-activated, in-vehicle connectivity system (requires XL Value Package and steering wheel-mounted audio controls)  
 MyKey® owner controls feature (requires Power Equipment Group and CD player)  
 Radio delete (Fleet only)  
 Rapid-heat supplemental cab heater (requires diesel engine and alternator upgrade)  
 Steering wheel-mounted audio controls (requires SYNC)

## EXTERIOR

6-in. angular Black molded cab steps  
 Daytime running lamps (Fleet only)  
 Exterior back-up alarm  
 Manual-sliding rear window with privacy glass (Fleet only)  
 Remote Start System (requires Power Equipment Group)  
 Transfer case skid plate (4x4 SuperCab and Crew Cab only)

## FORD WORK SOLUTIONS™

In-dash Windows® CE computer with touch screen navigation and hands-free calling (restrictions apply)<sup>1</sup>  
 Crew Chief™ – Fleet tracking system (n/a with in-dash computer)<sup>1</sup>

## PACKAGES

Power Equipment Group includes power door locks and front windows (plus rear on Crew Cab) with one-touch-down driver's side window feature; manually telescoping trailer tow mirrors with 2-way fold, power/heated glass, heated manual spotter mirrors, and integrated clearance lamps and turn signals; accessory delay; Remote Keyless Entry System with 2 integrated keyhead transmitter remotes; perimeter anti-theft alarm; and SecurILock®  
 XL Décor Group includes chrome front bumper (bright hub covers and center ornaments also included on SRW only)  
 XL Value Package includes AM/FM stereo/single-CD player with MP3 capability, digital clock, 4 speakers, cruise control, and chrome front bumper with grained top cover (bright hub covers and center ornaments also included on SRW only)  
 See **OPTIONAL PACKAGES** section on page 2 for content of the following packages:  
 16,000-lb. GVWR Package (F-450 only)  
 Ambulance Prep Package (Fleet only)  
 Extra-Heavy-Service Front Suspension Package  
 Heavy-Service Front Suspension Package  
 High-Capacity Trailer Tow Package (F-450/F-550 only)  
 Low Deflection Package (F-450/F-550 only)  
 Payload Downgrade Package (F-450/F-550 only)  
 Payload Upgrade Package (F-350 SRW only)  
 Payload Upgrade Package (F-550 with 141-in. WB and 6.8L gas engine only)  
 Payload Plus Upgrade Package (F-550 only)  
 Snow Plow Prep Package (restrictions apply)  
 Trailer Tow Package

<sup>1</sup>Ford Licensed Accessory.

## EXTERIOR

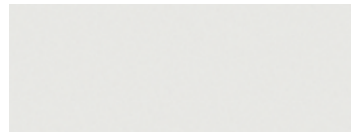

Oxford White



Vermillion Red



Dark Blue Pearl Metallic



Forest Green Metallic



Ingot Silver Metallic



Sterling Gray Metallic



Tuxedo Black Metallic

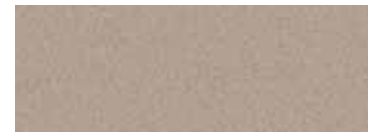

Pale Adobe Metallic (Fleet only)

## INTERIOR



Steel HD Vinyl Standard

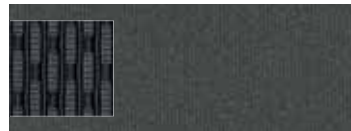

Steel Cloth Optional

## EXTERIOR COLORS

EXTERIOR COLORS	INTERIOR COLORS
Oxford White	■ ●
Vermillion Red	■ ●
Dark Blue Pearl Metallic	■ ●
Forest Green Metallic	■ ●
Ingot Silver Metallic	■ ●
Sterling Gray Metallic	■ ●
Tuxedo Black Metallic	■ ●
Pale Adobe Metallic	■ ●

**INTERIORS:** ■ Steel HD Vinyl ● Steel Cloth

## CAB AND SEATING CONFIGURATIONS

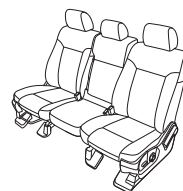

Standard 40/20/40 split front seat

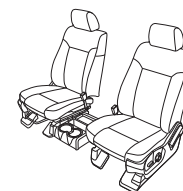

Available 40/mini-console/40 front bucket seats

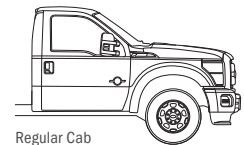

Regular Cab

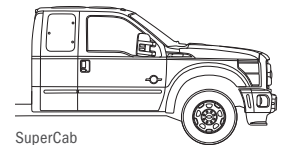

SuperCab

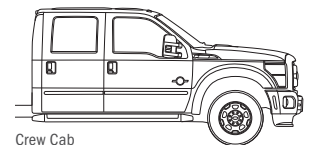

Crew Cab

Colors shown are representative only. See your dealer for actual paint/trim options.



# XLT



17-in. 5-Spoke Cast-Aluminum  
Standard on F-350 SRW



17-in. Argent-Painted Steel  
Standard on F-350 DRW



17-in. Forged Polished-Aluminum  
Optional on F-350 DRW



18-in. Cast-Aluminum  
Optional on F-350 SRW



19.5-in. Argent-Painted Steel  
Standard on F-450/F-550 DRW



19.5-in. Forged Polished-Aluminum  
Optional on F-450/F-550 DRW



XLT Crew Cab in Steel Cloth with flow-through center console and available equipment



F-450 XLT Regular Cab 4x4 in Vermillion Red with available and aftermarket equipment



# XLT OPTIONAL FEATURES

## MECHANICAL

- 6.7L Power Stroke® V8 Turbo Diesel B20-capable engine
- Electronic Shift-On-the-Fly (ESOF) 4-Wheel-Drive System with auto/manual locking hubs (4x4 models only; n/a with 6.8L gas engine)
- 17-in. argent-painted steel wheels (F-350 SRW; Fleet only)
- 17-in. forged polished-aluminum wheels (F-350 DRW)
- 18-in. cast-aluminum wheels (F-350 SRW)
- 19.5-in. forged polished-aluminum wheels (F-450/F-550)
- Stainless steel wheel covers<sup>1</sup> (requires 17-in. argent-painted steel DRW wheels or 19.5-in. argent-painted steel wheels)
- LT245/75R17 all-terrain BSW tires – 6 (F-350 DRW)
- LT245/75R17 all-terrain OWL tires – 4 (F-350 DRW)
- LT275/65R18 all-season BSW tires – 4 (F-350 SRW)
- LT275/70R18 all-terrain BSW tires – 4 (F-350 SRW 4x4)
- LT275/70R18 all-terrain OWL tires – 4 (F-350 SRW 4x4)
- 225/70R19.5G BSW traction tires – 2 all-season tires and 4 traction tires (F-450/F-550)
- 225/70R19.5G max traction BSW tires – 6 (F-450/F-550 4x4 only)
- CNG/LPG-fuel capable engine (F-450/F-550 only)
- Dual alternators with 357-amp total (diesel engine only)
- Engine block heater (standard in 15 cold-weather states)
- Fuel tank – 28-gallon midship (n/a w/189-in. WB Regular Cab or 200-in. WB Crew Cab with gas engines)
- Fuel tank – Dual tanks (40-gallon aft-of-axle and 28-gallon midship; DRW diesel engine only; n/a with SYNC or in-dash computer)
- Hydraulic jack (2-ton for F-350 SRW; 4-ton for F-350 DRW; 6-ton for F-450/F-550)
- Operator-commanded regeneration (diesel engine only)
- Power takeoff (PTO) provision (6.8L gas and 6.7L diesel engines only; includes transmission-mounted live drive and stationary modes with diesel engine only)
- Rear axle – Electronic-locking (F-350 SRW only)
- Rear axle – Higher-ratio (F-350 only)
- Rear axle – Limited-slip (DRW only)
- Spare tire/wheel/jack

## SEATING

- Cloth 40/console/40 front bucket seats and flow-through console with lockable storage, two 12-volt powerpoints and a 110-volt power inverter (SuperCab and Crew Cab only)

## INTERIOR

- All-weather floor mats
- Carpet delete (Fleet only)
- Ford SYNC® voice-activated, in-vehicle connectivity system (requires XLT Interior Package and steering wheel-mounted audio controls)
- Power-adjustable pedals (included in the XLT Interior Package; Fleet only option)
- Rapid-heat supplemental cab heater (requires diesel engine and alternator upgrade)
- Sirius Satellite Radio with 6-month trial subscription
- Steering wheel-mounted audio controls (requires SYNC)

## EXTERIOR

- 6-in. angular Black molded cab steps
- Daytime running lamps (Fleet only)
- Exterior back-up alarm
- Manual-sliding rear window with privacy glass (Regular Cab only)
- PowerScope™ power-telescoping/-folding trailer tow mirrors with power/heated glass, heated manual spotter mirrors, and integrated clearance lamps and turn signals
- Remote Start System
- Transfer case skid plate (4x4 SuperCab and Crew Cab only)

## FORD WORK SOLUTIONS™

- In-dash Windows® CE computer with touch screen navigation and hands-free calling (restrictions apply)<sup>1</sup>
- Crew Chief™ – Fleet tracking system (n/a with in-dash computer)<sup>1</sup>

## PACKAGES

- XLT Interior Package includes 6-way power driver seat, power-adjustable pedals, autolamp with rainlamp feature, autolock, auto-unlock and SecuriCode™ keyless entry keypad

See **OPTIONAL PACKAGES** section on page 2 for content of the following packages:

- 16,000-lb. GVWR Package (F-450 only)
- Ambulance Prep Package (Fleet only)
- Extra-Heavy-Service Front Suspension Package
- Heavy-Service Front Suspension Package
- High-Capacity Trailer Tow Package (F-450/F-550 only)
- Low Deflection Package (F-450/F-550 only)
- Payload Downgrade Package (F-450/F-550 only)
- Payload Upgrade Package (F-350 SRW only)
- Payload Upgrade Package (F-550 with 141-in. WB and 6.8L gas engine only)
- Payload Plus Upgrade Package (F-550 only)
- Snow Plow Prep Package (restrictions apply)

<sup>1</sup>Ford Licensed Accessory.

## EXTERIOR



## INTERIOR



## EXTERIOR COLORS

EXTERIOR COLORS	INTERIOR COLORS
Oxford White	● ●
Vermillion Red	● ●
Dark Blue Pearl Metallic	● ●
Forest Green Metallic	● ●
Ingot Silver Metallic	● ●
Sterling Gray Metallic	● ●
Tuxedo Black Metallic	● ●
Royal Red Metallic	● ●
Golden Bronze Metallic	● ●
Pale Adobe Metallic	● ●

**INTERIORS:** ● Adobe Cloth ● Steel Cloth

## CAB AND SEATING CONFIGURATIONS

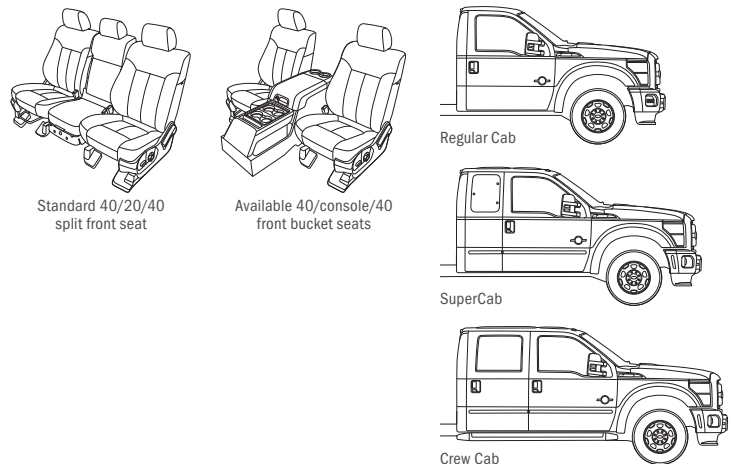

Colors shown are representative only. See your dealer for actual paint/trim options.



# LARIAT



LARIAT Crew Cab in Adobe Leather trim with available equipment



17-in. Forged Polished-Aluminum  
Standard on F-350 DRW



18-in. Bright-Machined Cast-Aluminum  
Standard on F-350 SRW



19.5-in. Forged Polished-Aluminum  
Standard on F-450/F-550 DRW



F-550 LARIAT Crew Cab 4x4 in Tuxedo Black with available and aftermarket equipment

2011 SUPER DUTY® CHASSIS CAB  
Specifications

[commtruck.ford.com](http://commtruck.ford.com)



# LARIAT OPTIONAL FEATURES

## MECHANICAL

- 6.7L Power Stroke® V8 Turbo Diesel B20-capable engine (F-350 only)
- LT245/75R17 all-terrain BSW tires – 6 (F-350 DRW)
- LT245/75R17 all-terrain OWL tires – 4 (F-350 DRW)
- LT275/70R18 all-terrain BSW tires – 4 (F-350 SRW 4x4)
- LT275/70R18 all-terrain OWL tires – 4 (F-350 SRW 4x4)
- 225/70R19.5G BSW traction tires – 2 all-season tires and 4 traction tires (F-450/F-550)
- 225/70R19.5G max traction BSW tires – 6 (F-450/F-550 4x4 only)
- Dual alternators with 357-amp total (diesel engine only)
- Engine block heater (standard in 15 cold-weather states)
- Fuel tank – 28-gallon midship (n/a w/189-in. WB Regular Cab or 200-in. WB Crew Cab with gas engines)
- Hydraulic jack (2-ton for F-350 SRW; 4-ton for F-350 DRW; 6-ton for F-450/F-550)
- Power takeoff (PTO) provision (6.8L gas and 6.7L diesel engines only; includes transmission-mounted live drive and stationary modes with diesel engine only)
- Rear axle – Electronic-locking (F-350 SRW only)
- Rear axle – Higher-ratio (F-350 only)
- Rear axle – Limited-slip (DRW only)
- Spare tire/wheel/jack

## SEATING

Premium leather-trimmed 40/20/40 split front seat with center under-seat lockable storage with 12-volt powerpoint and center armrest with cupholders and storage

## INTERIOR

- All-weather floor mats
- Rapid-heat supplemental cab heater (requires diesel engine and alternator upgrade)

## EXTERIOR

- 6-in. angular Black molded cab steps
- Exterior back-up alarm
- Remote Start System (included with LARIAT Interior Package)
- Transfer case skid plate (4x4 only)

## FORD WORK SOLUTIONS™

- Crew Chief™ – Fleet tracking system<sup>1</sup>

## PACKAGES

LARIAT Interior Package includes easy-entry/-exit, memory, power, heated/cooled driver seat; power, heated/cooled passenger seat; memory, power trailer tow mirrors; memory, power-adjustable pedals; and Remote Start System

See **OPTIONAL PACKAGES** section on page 2 for content of the following packages:

- 16,000-lb. GVWR Package (F-450 only)
- Ambulance Prep Package (Fleet only)
- Extra-Heavy-Service Front Suspension Package
- Heavy-Service Front Suspension Package
- High-Capacity Trailer Tow Package (F-450/F-550 only)
- Low Deflection Package (F-450/F-550 only)
- Payload Downgrade Package (F-450/F-550 only)
- Payload Upgrade Package (F-350 SRW only)
- Payload Plus Upgrade Package (F-550 only)
- Snow Plow Prep Package (restrictions apply)

<sup>1</sup>Ford Licensed Accessory.

## EXTERIOR



## INTERIOR



## EXTERIOR COLORS

## INTERIOR COLORS

Oxford White	■	■
Vermillion Red	■	■
Dark Blue Pearl Metallic	■	■
Forest Green Metallic	■	■
Ingot Silver Metallic	■	■
Sterling Gray Metallic	■	■
Tuxedo Black Metallic	■	■
Royal Red Metallic	■	■
Golden Bronze Metallic	■	■
White Platinum Metallic Tri-coat <sup>2</sup>	■	■
Pale Adobe Metallic	■	■

**INTERIORS:** ■ Adobe Leather ■ Black Leather  
<sup>2</sup>Additional-cost option.

## CAB AND SEATING CONFIGURATIONS



Standard 40/console/40 front bucket seats

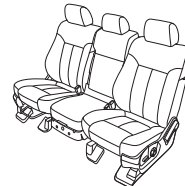

Available 40/20/40 split front seat

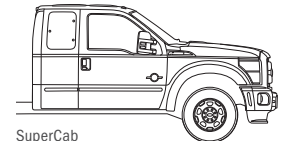

SuperCab

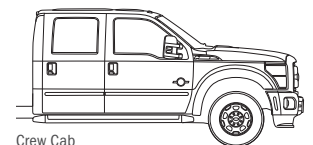

Crew Cab

Colors shown are representative only. See your dealer for actual paint/trim options.

# TECHNICAL SPECIFICATIONS

## 5TH-WHEEL TOWING — MAXIMUM LOADED TRAILER WEIGHT RATINGS (LBS.)<sup>1</sup>

### AUTOMATIC TRANSMISSION

ENGINE	AXLE RATIO	GCWR (LBS.)	F-350 SRW 4x2	F-350 DRW 4x2	F-350 SRW 4x4	F-350 DRW 4x4	F-450 DRW 4x2	F-450 DRW 4x4	F-550 DRW 4x2	F-550 DRW 4x4
<b>REGULAR CAB</b> 6.2L 2-valve Gas V8 FFV	3.73	19,000	12,400	—	12,000	—	—	—	—	—
	4.30	19,500	—	13,300	—	11,900	—	—	—	—
		22,000	15,400	—	15,000	—	—	—	—	—
		22,500	—	16,300	—	14,900	—	—	—	—
6.8L 3-valve Gas V10	4.88	26,000	—	—	—	—	18,300	18,000	18,300	18,000
6.7L Diesel V8	3.73	23,500	16,100	—	15,500	—	—	—	—	—
	4.10	24,500	—	16,500	—	16,100	—	—	—	—
	4.30	26,000	—	16,500	—	16,100	—	—	—	—
	4.88	30,000 <sup>2</sup>	—	—	—	—	17,500	17,200	17,500	17,200
		35,000 <sup>2</sup>	—	—	—	21,500	21,200	—	26,500	26,200
		26,000	—	—	—	—	—	—	18,100	17,800
		35,000 <sup>2</sup>	—	—	—	—	—	—	26,400	26,000
<b>SUPERCAB</b> 6.2L 2-valve Gas V8 FFV	3.73	19,000	12,000	—	11,600	—	—	—	—	—
	4.30	19,500	—	12,000	—	11,500	—	—	—	—
		22,000	15,000	—	14,600	—	—	—	—	—
		22,500	—	15,000	—	14,500	—	—	—	—
6.8L 3-valve Gas V10	4.88	26,000	—	—	—	—	17,800	17,500	17,800	17,500
6.7L Diesel V8	3.73	23,500	15,500	—	15,100	—	—	—	—	—
	4.10	24,500	—	16,200	—	15,700	—	—	—	—
	4.30	26,000	—	16,200	—	15,700	—	—	—	—
	4.88	30,000 <sup>2</sup>	—	—	—	—	17,000	16,800	17,000	16,800
		35,000 <sup>2</sup>	—	—	—	—	21,000	20,800	—	25,800
		26,000	—	—	—	—	—	—	26,000	25,800
		35,000 <sup>2</sup>	—	—	—	—	—	—	17,700	17,300
			—	—	—	—	—	—	25,800	25,600
<b>CREW CAB</b> 6.2L 2-valve Gas V8 FFV	3.73	19,000	11,700	—	11,400	—	—	—	—	—
	4.30	19,500	—	11,700	—	11,300	—	—	—	—
		22,000	14,700	—	14,200	—	—	—	—	—
		22,500	—	14,700	—	14,300	—	—	—	—
6.8L 3-valve Gas V10	4.88	26,000	—	—	—	—	17,600	17,300	17,600	17,300
6.7L Diesel V8	3.73	23,500	15,300	—	14,800	—	—	—	—	—
	4.10	24,500	—	16,000	—	15,500	—	—	—	—
	4.30	26,000	—	16,000	—	15,500	—	—	—	—
	4.88	30,000 <sup>2</sup>	—	—	—	—	16,800	16,500	16,800	16,500
		35,000 <sup>2</sup>	—	—	—	—	20,800	20,500	—	25,500
		26,000	—	—	—	—	—	—	17,500	17,200
		35,000 <sup>2</sup>	—	—	—	—	—	—	25,600	25,300

<sup>1</sup>F-350 DRW/F-450/F-550 weights shown are for 141-in. wheelbase Regular Cab or 176-in. wheelbase Crew Cab models. For 165-in., 189-in., 200-in. and 201-in. wheelbase models, weights may be somewhat less (usually not more than 200 lbs., or 400 lbs. with 201-in. wheelbase). <sup>2</sup>Requires optional Payload Upgrade Package. **5th-Wheel Towing Notes:** Trailer weights shown assume 1,000 lbs. second-unit body weight. Be sure combined weight of vehicle and trailer does not exceed listed GCWR. Trailer kingpin weight should be 15-25% of total loaded trailer weight. Make sure that the vehicle payload (reduced by option weight) will accommodate trailer kingpin weight and the weight of passengers and cargo added to the towing vehicle. The addition of trailer kingpin weight, and the weight of passengers and cargo, cannot cause vehicle weights to exceed the rear GAWR (Gross Axle Weight Rating) or GVWR (Gross Vehicle Weight Rating). These ratings can be found on the vehicle's Safety Compliance Certification Label. See your Ford Dealer for conventional trailer weights.

### DIMENSIONS & WEIGHTS

	REGULAR CAB										
	F-350 SRW 4x2/4x4	F-350 DRW <sup>3</sup> 4x2/4x4	F-350 DRW <sup>3</sup> 4x2/4x4	F-450 DRW 4x2/4x4	F-450 DRW 4x2/4x4	F-450 DRW 4x2/4x4	F-450 DRW 4x2/4x4	F-450 DRW 4x2/4x4	F-550 DRW 4x2/4x4	F-550 DRW 4x2/4x4	F-550 DRW 4x2/4x4
Wheelbase	140.8"	140.8"	164.8"	140.8"	140.8"	188.8"	200.8"	140.8"	164.8"	188.8"	200.8"
Cab-to-axle	60"	60"	84"	60"	84"	108"	120"	60"	84"	108"	120"
<b>EXTERIOR</b>											
Height											
Top of cab to ground	76.9"/79.9"	77.3"/80.3"	77.3"/80.3"	80.3"/80.4"	80.4"	80.6"/80.4"	80.6"/80.5"	80.4"/80.5"	80.7"/80.5"	80.7"	80.9"/80.7"
Top of frame to ground	32.0"/34.2"	32.6"/34.7"	32.3"/34.2"	33.2"/33.4"	33.0"	32.8"/32.9"	32.8"	33.7"/33.8"	33.4"	33.3"/33.2"	33.2"
Width between frame rails	34.1"	34.1"	34.1"	34.2"	34.2"	34.2"	34.2"	34.2"	34.2"	34.2"	34.2"
Axle clearance	8.6"	8.2"/8.1"	8.2"	8.1"/8.0"	8.1"	8.1"/8.0"	8.1"	8.4"	8.4"	8.4"	8.4"
Front track	68.3"	68.3"	68.3"	74.8"	74.8"	74.8"	74.8"	74.8"	74.8"	74.8"	74.8"
Rear tire outside width	79.6"	92.2"	92.2"	93.9"	93.9"	93.9"	93.9"	93.9"	93.9"	93.9"	93.9"
Overall length	226.5"	226.5"	250.5"	226.5"	250.5"	274.5"	286.5"	226.5"	250.5"	274.5"	286.5"
<b>INTERIOR (front/rear)</b>											
Head room	40.7"/—	40.7"/—	40.7"/—	40.7"/—	40.7"/—	40.7"/—	40.7"/—	40.7"/—	40.7"/—	40.7"/—	40.7"/—
Shoulder room	68.0"/—	68.0"/—	68.0"/—	68.0"/—	68.0"/—	68.0"/—	68.0"/—	68.0"/—	68.0"/—	68.0"/—	68.0"/—
Hip room	67.6"/—	67.6"/—	67.6"/—	67.6"/—	67.6"/—	67.6"/—	67.6"/—	67.6"/—	67.6"/—	67.6"/—	67.6"/—
Leg room	41.1"/—	41.1"/—	41.1"/—	41.1"/—	41.1"/—	41.1"/—	41.1"/—	41.1"/—	41.1"/—	41.1"/—	41.1"/—
<b>WEIGHTS</b>											
Max. GVWR <sup>4</sup>	11,100	13,000	13,000	16,500	16,500	16,500	16,500	19,500	19,500	19,500	19,500
Max. payload <sup>4</sup>	4,762/4,256	7,522/6,868	7,222/6,835	9,976/9,675	9,837/9,519	9,597/9,171	9,508/9,111	12,304/11,958	12,761/12,345	12,553/12,101	12,432/12,051

<sup>3</sup>Ambulance Prep Package F-350 DRW: tire front track is 74.1-in.; rear tire outside width is 95.2-in. <sup>4</sup>When properly equipped.

**Note:** Load rating represents maximum allowable weight of people, cargo and body equipment and is reduced by the weight of optional equipment. SRW = single rear wheel DRW = dual rear wheel

# 2011

## SUPER DUTY® CHASSIS CAB

### Specifications

commtruck.ford.com



## MECHANICAL

### FRONT SUSPENSION

Type	Twin-I-Beam (F-350 4x2); solid twin-coil monobeam axle (F-350 4x4, F-450/F-550)
Axle (rating @ ground)	5,250 lbs. (F-350 4x2); 6,000 lbs. (F-350 4x4); 7,000 lbs. (F-450/F-550)
Springs	Coil
Shock absorbers	1.38" gas type
Stabilizer bar	Standard

### REAR SUSPENSION

Type	Solid axle
Axle (rating @ ground)	7,280 lbs. (F-350 SRW); 9,750 lbs. (F-350 DRW); 12,000 lbs. (F-450); 13,660 lbs. (F-550)
Springs	Leaf
Shock absorbers	1.38" gas type
Stabilizer bar	Standard

### STEERING

Type	Parallel linkage (F-350 4x2); cross-tie linkage (4x4 and F-450/F-550 4x2)
Assist	Power
Overall ratio	20.49:1 (F-350 4x2); 20.41:1 (F-350 4x4); 17.8:1 average (F-450/F-550)

### BRAKES

Type	4-wheel vented-disc ABS (standard)
Front	
Rotor diameter	13.66" (F-350); 14.53" (F-450/F-550)
Lining area (sq. in.)	34.9 (F-350); 55.6 (F-450/F-550)
Rear	
Rotor diameter	13.39" (F-350); 15.35" (F-450/F-550)
Lining area (sq. in.)	38.2 (F-350); 55.6 (F-450/F-550)

### WHEELS

Type	Steel (standard); aluminum (optional)
Size	17" SRW/DRW, 18" SRW (F-350); 19.5" (F-450/F-550)
Number of studs	8 (F-350); 10 (F-450/F-550)
Bolt-circle diameter	6.7" (F-350 SRW); 7.87" (F-350 DRW); 8.85" (F-450/F-550)

## POWERTRAINS

	6.7L V8 TURBO DIESEL	6.2L 2-VALVE GAS V8 FFV <sup>1</sup>	6.8L 3-VALVE GAS V10
Configuration	OHV (32-valve)	SOHC	SOHC
Fuel injection	High-pressure common-rail	Sequential electronic	Sequential electronic
Engine control system	Electronic	Electronic	Electronic
Induction system	Single-sequential turbocharger with charged air cooler	Specially tuned	Specially tuned
Battery	Dual 12-volt; 750-CCA/78-amp-hr	12-volt; 650-CCA/72-amp-hr	12-volt; 650-CCA/72-amp-hr
Alternator	157-amp (single 200-amp or dual combined 357-amp, optional)	157-amp	157-amp
Cooling system	Pressurized series flow	Pressurized series flow	Pressurized series flow
Oil-life monitor	Intelligent Oil-Life Monitor™	Oil-minder system	Oil-minder system
Cylinders	8	8	10
Cylinder head	Aluminum	Aluminum	Aluminum
Block material	Compacted graphite iron	Cast iron	Cast iron
Valve operation	Push rod/rocker arms	Roller-rocker shaft	Hydraulic roller
Camshaft drive	Gear	Silent chain	Silent chain
Bore	3.90"	4.02"	3.55"
Stroke	4.25"	3.74"	4.17"
Compression ratio	16.2:1	9.8:1	9.2:1
Horsepower/rpm	300 @ 2800	385 @ 5500 <sup>2</sup> /316 @ 4179 <sup>3</sup>	362 @ 4750
Torque lb.-ft./rpm	660 @ 1600	405 @ 4500 <sup>2</sup> /397 @ 4179 <sup>3</sup>	457 @ 3250
Recommended fuel	Ultra-low-sulfur diesel or B20 (containing 20% or less biodiesel)	Regular unleaded or E85	Regular unleaded

<sup>1</sup>Certified to SAE J1349. <sup>2</sup>Under 10K GVWR. <sup>3</sup>Over 10K GVWR.

## TRANSMISSION

Type	6-speed TorqShift® automatic with SelectShift (6.7L diesel, 6.2L gas)	5-speed TorqShift automatic (6.8L gas V10)
Case material	Aluminum	Aluminum
PTO	Live-Drive access on driver side (diesel only)	Access on driver side
Gear ratios	1st 3.97:1 2nd 2.32:1 3rd 1.52:1 4th 1.15:1 5th 0.86:1 6th 0.67:1 Reverse 3.13:1	3.11:1 2.20:1 1.55:1 1.00:1 0.71:1 — 2.88:1

## DIMENSIONS & WEIGHTS (cont.)

	SUPERCAB						CREW CAB					
	F-350 SRW 4x2/4x4	F-350 DRW <sup>4</sup> 4x2/4x4	F-450 DRW 4x2/4x4	F-450 DRW 4x2/4x4	F-550 DRW 4x2/4x4	F-550 DRW 4x2/4x4	F-350 SRW 4x2/4x4	F-350 DRW <sup>4</sup> 4x2/4x4	F-450 DRW 4x2/4x4	F-450 DRW 4x2/4x4	F-550 DRW 4x2/4x4	F-550 DRW 4x2/4x4
Wheelbase	161.8"	161.8"	161.8"	185.8"	161.8"	185.8"	176.2"	176.2"	176.2"	200.2"	176.2"	200.2"
Cab-to-axle	60"	60"	60"	84"	60"	84"	60"	60"	60"	84"	60"	84"
<b>EXTERIOR</b>												
Height												
Top of cab to ground	76.7"/79.7"	77.0"/80.1"	80.3"	80.4"	80.4"	80.5"	77.7"/80.5"	78.0"/80.8"	80.6"	80.6"	80.8"	80.9"/80.8"
Top of frame to ground	31.7"/33.5"	32.2"/34.1"	32.9"/32.8"	32.8"/32.7"	33.4"/33.3"	33.3"/33.2"	31.4"/33.3"	32.1"/34.0"	32.9"/32.8"	32.8"/32.7"	33.3"	33.2"
Width between frame rails	34.1"	34.1"	34.2"	34.2"	34.2"	34.2"	34.1"	34.1"	34.2"	34.2"	34.2"	34.2"
Axle clearance	8.6"	8.2"	8.0"	8.0"	8.4"	8.4"	8.6"	8.2"	8.0"	8.0"	8.4"	8.4"
Front track	68.3"	68.3"	74.8"	74.8"	74.8"	74.8"	68.3"	68.3"	74.8"	74.8"	74.8"	74.8"
Rear tire outside width	79.6"	92.2"	93.9"	93.9"	93.9"	93.9"	79.6"	92.2"	93.9"	93.9"	93.9"	93.9"
Overall length	247.5"	247.5"	247.5"	271.5"	247.5"	271.5"	261.9"	261.9"	261.9"	285.9"	261.9"	285.9"
<b>INTERIOR (front/rear)</b>												
Head room	40.7"/38.1"	40.7"/38.1"	40.7"/38.1"	40.7"/38.1"	40.7"/38.1"	40.7"/38.1"	40.7"/40.8"	40.7"/40.8"	40.7"/40.8"	40.7"/40.8"	40.7"/40.8"	40.7"/40.8"
Shoulder room	68.0"/68.1"	68.0"/68.1"	68.0"/68.1"	68.0"/68.1"	68.0"/68.1"	68.0"/68.1"	68.0"	68.0"	68.0"	68.0"	68.0"	68.0"
Hip room	67.6"/67.3"	67.6"/67.3"	67.6"/67.3"	67.6"/67.3"	67.6"/67.3"	67.6"/67.3"	67.6"	67.6"	67.6"	67.6"	67.6"	67.6"
Leg room	41.1"/31.6"	41.1"/31.6"	41.1"/31.6"	41.1"/31.6"	41.1"/31.6"	41.1"/31.6"	41.1"/42.1"	41.1"/42.1"	41.1"/42.1"	41.1"/42.1"	41.1"/42.1"	41.1"/42.1"
<b>WEIGHTS</b>												
Max. GVWR <sup>5</sup>	11,500	13,000	16,500	16,500	19,500	19,500	11,500	13,000	16,500	16,500	19,500	19,500
Max. payload <sup>5</sup>	4,725/4,296	6,954/6,468	9,545/9,218	9,121/9,000	12,431/12,021	12,252/11,701	4,468/4,031	6,720/6,251	9,326/8,999	9,217/8,868	12,214/11,866	12,091/11,723

<sup>4</sup>Ambulance Prep Package F-350 DRW: tire front track is 74.1-in.; rear tire outside width is 95.2-in. <sup>5</sup>When properly equipped.

2011 SUPER DUTY® CHASSIS CAB  
Specifications

commtruck.ford.com

