



2022
TAHOE

Announce your arrival.

You've reached the top. Now prepare to embrace everything the world has to offer in the most versatile and advanced Tahoe ever. It's spacious, with 122.9 cubic feet of maximum cargo volume¹ and 10 inches more third-row leg room than the previous generation. It's capable, thanks to its Premium Smooth Ride suspension and three available powertrains. And it inspires confidence, with standard Chevy Safety Assist²; a comprehensive suite of six driver assistance features. You've earned your success. Enjoy it in the 2022 Tahoe.



Tahoe High Country in Evergreen Gray Metallic.

¹ With second- and third-row seats folded flat. Cargo and load capacity limited by weight and distribution. ² Chevy Safety Assist includes Automatic Emergency Braking, Front Pedestrian Braking, Lane Keep Assist with Lane Departure Warning, Forward Collision Alert, IntelliBeam and Following Distance Indicator. Safety or driver assistance features are no substitute for the driver's responsibility to operate the vehicle in a safe manner. Read the vehicle Owner's Manual for important feature limitations and information.

Due to current supply chain shortages, certain features shown have limited or late availability, or are no longer available. See the window label or a dealer regarding the features on an individual vehicle.

INTRODUCING TAHOE

Tahoe at a glance.

- Full-size SUV with multiple seating options, including room for up to 9 on LS with the available front bench seat
- Six models: LS, LT, RST, Z71, Premier and High Country
- Available as 2WD or 4WD (4WD standard on Z71)
- Three engine choices, each paired with a 10-speed automatic transmission
 - 5.3L EcoTec3 V8 with Dynamic Fuel Management
 - 6.2L EcoTec3 V8 with Dynamic Fuel Management
 - Duramax® 3.0L Turbo-Diesel I-6
- 8,400 lbs. of maximum towing capability¹
- Available Four-Corner Air Ride Adaptive Suspension on Z71 and High Country
- Chevy Safety Assist² standard on all models
 - Automatic Emergency Braking
 - Front Pedestrian Braking
 - Lane Keep Assist with Lane Departure Warning
 - Forward Collision Alert
 - IntelliBeam®
 - Following Distance Indicator
- 122.9 cubic feet of maximum cargo volume³
- Available Advanced Trailering System with in-vehicle app⁴ and Smart Trailer Integration Indicator
- Available Rear-Seat Media System
- Google built-in⁵ compatibility included on LT, RST, Z71, Premier and High Country
- Up to 13 available camera views⁶



Up to 8,400 lbs. of maximum towing capability!



Tahoe High Country interior in Jet Black/Mocha.

¹ Requires 2WD, 5.3L engine and available Max Trailering Package. Maximum trailering ratings are intended for comparison purposes only. Before you buy a vehicle or use it for trailering, carefully review the Trailering section of the Owner's Manual. The trailering capacity of your specific vehicle may vary. The weight of passengers, cargo and options or accessories may reduce the amount you can trailer. ² Safety or driver assistance features are no substitute for the driver's responsibility to operate the vehicle in a safe manner. Read the vehicle Owner's Manual for important feature limitations and information. ³ With second- and third-row seats folded flat. Cargo and load capacity limited by weight and distribution. ⁴ App functionality and features vary with vehicle equipment and trim level. Data connection may be required. Some features require active service plan and working electrical system. Terms and conditions apply. ⁵ Google built-in services are subject to limitations and availability may vary by vehicle, infotainment system and location. Select service plan required. Certain Google actions and functionality may require account linking. User terms and privacy statements apply. ⁶ Safety or driver assistance features are no substitute for the driver's responsibility to operate the vehicle in a safe manner. Read the vehicle Owner's Manual for important feature limitations and information. Some camera views require available accessory camera and installation. Not compatible with all trailers. See your dealer for details.

Due to current supply chain shortages, certain features shown have limited or late availability, or are no longer available. See the window label or a dealer regarding the features on an individual vehicle.

MODELS

Six models to choose from.

Where Tahoe is involved, every choice is the right one.



LS

Tahoe LS brings you the things you need in a full-size SUV, and so much you never expected.

- 5.3L EcoTec3 V8 engine
- Premium Smooth Ride suspension
- 18-inch Bright Silver-painted aluminum wheels
- Body-color mirror caps and door handles
- Black lower fascia with chrome accents
- Black assist steps with chrome strip
- Bright roof rack side rails
- LED headlamps, taillamps and daytime running lamps
- Remote vehicle starter system
- 10-way power driver-seat adjuster with power lumbar control
- Fold-flat second- and third-row seats
- Tri-zone automatic climate controls
- Chevrolet Infotainment 3 system¹ with 8-inch diagonal color touch-screen
- Chevy Safety Assist^{2,3}
- HD Rear Vision Camera³



LT

Comfort and convenience are elevated in nearly every way in the 2022 Tahoe LT.

- Hands-free programmable power liftgate with Chevrolet emblem projection
- Black grille with Black inserts and chrome accents
- Bright front and rear sill plates
- Leather-appointed front and second-row seats
- 12-inch diagonal multi-color enhanced Driver Information Center
- Inside rearview auto-dimming mirror
- Universal Home Remote
- Chevrolet Infotainment 3 Premium system¹ with 10.2-inch diagonal color touch-screen and Google built-in⁴ compatibility
- 9-speaker Bose sound system
- Wireless charging⁵



RST

Be prepared. Everything about RST is designed to get you noticed.

- RST-specific Black sport grille
- Black Ice chrome exterior trim
- Black Chevrolet bowtie emblems
- RST-specific badging
- 22-inch bright machined high-gloss Black-painted aluminum wheels
- Black front fascia with gloss Black accent trim
- Black roof rack side rails
- Black assist steps with gloss Black accents
- Gloss Black beltline moldings
- Black Ice chrome finish liftgate appliqué
- RST-specific Jet Black interior with Victory Red stitching

¹ Chevrolet Infotainment System functionality varies by model. Full functionality requires compatible Bluetooth and smartphone, and USB connectivity for some devices. ² Chevy Safety Assist includes Automatic Emergency Braking, Front Pedestrian Braking, Lane Keep Assist with Lane Departure Warning, Forward Collision Alert, IntelliBeam and Following Distance Indicator. ³ Safety or driver assistance features are no substitute for the driver's responsibility to operate the vehicle in a safe manner. Read the vehicle Owner's Manual for important feature limitations and information. ⁴ Google built-in services are subject to limitations and availability may vary by vehicle, infotainment system and location. Select service plan required. Certain Google actions and functionality may require account linking. User terms and privacy statements apply. ⁵ The system wirelessly charges one compatible mobile device. Some phones have built-in wireless charging technology and others require a special adaptor/back cover. To check for phone or other device compatibility, visit my.chevrolet.com/learn or consult your carrier.

Due to current supply chain shortages, certain features shown have limited or late availability, or are no longer available. See the window label or a dealer regarding the features on an individual vehicle.

MODELS (CONTINUED)

Six models to choose from.

Where Tahoe is involved, every choice is the right one.



Z71

In Z71, the world opens up and all roads lead to adventure.

- Autotrac® 2-speed active transfer case
- Hill Descent Control
- Heavy-duty air filter
- Front skid plate with Galvano finish
- 20-inch machined-aluminum wheels with all-terrain tires
- Black grille with Black Ice chrome accents
- High approach angle front fascia
- Red recovery hooks¹
- Gloss Black beltline moldings
- Black tubular assist steps
- Black Chevrolet bowtie emblems and Black badging
- Black roof rack side rails
- Black Ice chrome finish liftgate appliqué



Premier

It may seem as if there's no end to the upscale amenities you'll find in Tahoe Premier.

- Magnetic Ride Control™
- Dual exhaust system with dual twin tips²
- Chrome door handles with body-color strips
- Black grille with bright chrome inserts and Galvano accents
- 20-inch polished-finish aluminum wheels
- Full-feature outside mirrors with chrome caps
- Power-release second-row bucket seats
- Power-folding third-row seat
- Bose Centerpoint Surround Sound 10-speaker system
- Lane Change Alert with Side Blind Zone Alert,³ Rear Cross Traffic Alert³ and Safety Alert Seat³



High Country

You're in total command of your world. Now it's time to experience that success in High Country.

- 6.2L EcoTec3 V8 engine
- 22-inch Sterling Silver-painted wheels
- Exclusive grille with Galvano inserts and Godric accents
- Black lower front fascia with Galvano accent
- Body-color mirror caps
- Galvano finish liftgate appliqué
- Bright front and rear sill plates with High Country logo
- Heated and ventilated front seats with perforated leather seating surfaces⁴
- Heated second-row bucket seats
- 15-inch diagonal multi-color Head-Up Display
- Rear Camera Mirror³
- Rear Pedestrian Alert³
- HD Surround Vision³

¹ To avoid the risk of injury, never use recovery hooks to tow a vehicle. For more information, see the Recovery Hooks section of your Owner's Manual. ² Requires gas engine. ³ Safety or driver assistance features are no substitute for the driver's responsibility to operate the vehicle in a safe manner. Read the vehicle Owner's Manual for important feature limitations and information. ⁴ Leather seating surfaces in front and second rows; third row is vinyl-covered.

Due to current supply chain shortages, certain features shown have limited or late availability, or are no longer available. See the window label or a dealer regarding the features on an individual vehicle.

CAMERA TECHNOLOGIES

Take a look around.

The 2022 Tahoe offers up to 13 available camera views to help make it easier to pull into tight spaces, back into a garage or hitch a trailer – helping to provide confidence and a feeling of security when you drive.

- Three available hitch views¹
 - Hitch View
 - Surround View
 - Rear Top-Down View
- Six available driving views¹
 - Transparent Trailer View²
 - Front Camera View
 - Pic-In-Pic Side View²
 - Rear Camera Mirror
 - Rear Trailer View²
 - Inside Trailer View²
- Four available parking views¹
 - Rear Camera View
 - Rear Side View
 - Front Side View
 - Front Top-Down View



Transparent Trailer View²



Rear Camera View¹

¹ Safety or driver assistance features are no substitute for the driver's responsibility to operate the vehicle in a safe manner. The driver should remain attentive to traffic, surroundings and road conditions at all times. Visibility, weather and road conditions may affect feature performance. Read the vehicle Owner's Manual for more important feature limitations and information. Some camera views require available accessory camera and installation. Not compatible with all trailers. See your dealer for details.

² Requires available Chevrolet Accessory Camera and installation. Not compatible with all trailers. Customers can see their dealer for full details.

STANDARD EQUIPMENT

Standard on every Tahoe:

MECHANICAL

Air filter – engine air filtration monitor

Brakes – 4-wheel antilock, 4-wheel disc with Duralife® rotors; electronic parking brake

Cooling – external engine oil cooler (5.3L V8 and 6.2L V8 engine)
– transmission oil cooler

Differential – mechanical limited-slip

Driver Mode Selector – with Tow/Haul mode

StabiliTrak® – Electronic Stability Control System and Traction Control; includes Electronic Trailer Sway Control and Hill Start Assist

Steering – rack-and-pinion with electric assist

Trailer equipment – trailer hitch platform, 7-wire harness with independent fused trailering circuits mated to a 7-way sealed connector, 2-inch trailering receiver and Hitch Guidance¹

Transmission – 10-speed automatic, electronically controlled with overdrive and Electronic Precision Shift

EXTERIOR

Active aero shutters – upper

Daytime running lamps – LED

Fuel filler – capless fueling

Glass – solar-absorbing with acoustic-laminated windshield and deep-tinted rear windows

Headlamps – LED, automatic on/off with automatic delay

Taillamps – LED

Tire – 17" full-size spare, lockable, mounted under frame at rear

Wipers – front variable-speed, intermittent with Rainsense®; rear intermittent with washer

INTERIOR

Chevy Safety Assist¹

Automatic Emergency Braking

Front Pedestrian Braking

Lane Keep Assist with Lane Departure Warning

Forward Collision Alert

IntelliBeam, auto high beams

Following Distance Indicator

INTERIOR (CONTINUED)

Airbags² – frontal airbags for driver and front outboard passenger; seat-mounted side-impact airbags for driver and front outboard passenger; driver inboard seat-mounted side-impact airbag (requires front bucket seats on LS); head-curtain airbags for all rows in outboard seating positions; includes front outboard Passenger Sensing System for frontal outboard passenger airbag

Air conditioning – tri-zone automatic climate controls, with individual climate settings for driver, right-front passenger and rear passengers; rear air conditioning

Buckle to Drive

Cargo area – Cargo Management System

Connectivity – wireless Apple CarPlay^{®3} and wireless Android Auto^{™4} compatibility

Cruise control – electronic with Set and Resume Speed

Defogger – electric rear-window

Door locks – power programmable with lockout protection and manual rear door child security

Floor mats – front and second-row carpeted

Keyless Open and Start – includes extended-range Remote Keyless Entry

Lighting – interior lighting with door handle or Remote Keyless Entry-activated illuminated entry, cargo area, and front and second-row reading lamps

Media – two USB ports⁵ on center stack, two USB ports⁵ in center console, two USB ports⁵ in second row on rear of center console, and two USB ports⁵ in third row

Power outlets – three, one 12-volt in center stack, one 120-volt on rear of center console and one 120-volt in cargo area

Rear Seat Reminder⁶

HD Rear Vision Camera¹

Remote vehicle starter system

SiriusXM[®] with 360L⁷ – 3-month trial subscription

Steering wheel – leather-wrapped with mounted audio, cruise, phone and Driver Information Center controls

Teen Driver technology¹

Theft-deterrent system – unauthorized entry

Tire Pressure Monitoring System – with Tire Fill Alert (does not monitor spare tire)

Visors – driver and front passenger, covered illuminated vanity mirrors, sliding

Windows – power with driver and front passenger express-up/-down, all others express-down

¹ Safety or driver assistance features are no substitute for the driver's responsibility to operate the vehicle in a safe manner. Read the vehicle Owner's Manual for important feature limitations and information. ² A NOTE ON CHILD SAFETY: Always use seat belts and the correct child restraint for your child's age and size, even with airbags. Even in vehicles equipped with the Passenger Sensing System, children are safer when properly secured in a rear seat in the appropriate infant, child or booster seat. Never place a rear-facing infant restraint in the front seat of any vehicle equipped with an active frontal airbag. See your vehicle Owner's Manual and the child safety seat instructions for more safety information. ³ Vehicle user interface is a product of Apple and its terms and privacy statements apply. Requires compatible iPhone and data plan rates apply. ⁴ Vehicle user interface is a product of Google and its terms and privacy statements apply. To use Android Auto on your car display, you'll need an Android phone running Android 6 or higher, an active data plan, and the Android Auto app. ⁵ Not compatible with all devices. ⁶ Does not detect people or items. Always check rear seat before exiting. ⁷ If you decide to continue service after your trial, your selected subscription plan will automatically renew thereafter. You will be charged at then-current rates. Fees and taxes apply. To cancel you must call SiriusXM at 1-866-635-2349. See SiriusXM Customer Agreement for complete terms at siriusxm.com. All fees and programming subject to change. Certain features require a SiriusXM subscription and the Chevrolet Connected Access plan. See siriusxm.com and onstar.com for details and limitations.

LS EXTERIOR COLORS



Summit White



Satin Steel Metallic



Dark Ash Metallic



Empire Beige Metallic



Auburn Metallic



Cherry Red Tintcoat¹



Evergreen Gray Metallic



Midnight Blue Metallic



Black

¹Extra-cost color.

LS FEATURES



In addition to standard equipment, select LS features include:

MECHANICAL

Engine – 5.3L EcoTec3 V8 with Dynamic Fuel Management, Variable Valve Timing (VVT) and Direct Injection

Exhaust – single system with single-outlet

Suspension – 4-wheel independent, Premium Smooth Ride

EXTERIOR

Assist steps – Black with chrome accent strip

Chevrolet bowtie emblems – Gold

Door handles – body-color

Fascia – front lower, Black with bright chrome accent trim

Grille – Black mesh with bright chrome center bar

Liftgate – manual

Liftgate appliqué – bright chrome finish

Mirrors – heated, power-adjustable, manual-folding with body-color mirror caps

Roof rack side rails – bright

INTERIOR

Audio – 6-speaker system

Console – with storage area and removable storage tray

Driver Information Center – 4.2-inch diagonal color display, includes driver personalization

Entertainment – Chevrolet Infotainment 3 system¹ with 8-inch diagonal color touch-screen

Mirror – rearview, manual day/night

Seating – 8-passenger with front bucket seats and second- and third-row manual-folding 60/40 split-bench seats

Seats – driver 10-way power adjuster with power lumbar control and front passenger 8-way power adjuster with power lumbar control

Steering column – manual tilt and telescopic

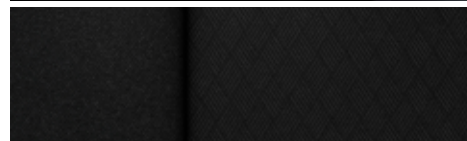

Jet Black Premium Cloth (shown)

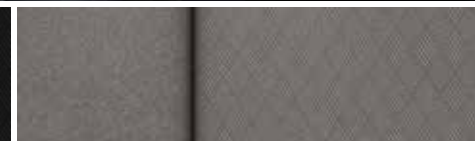

Gideon Premium Cloth



18" Bright Silver-Painted Aluminum Wheels (PZX)
Standard on LS



20" Painted-Aluminum Wheels with
Machined Face and Argent Metallic Pockets (RD4)
Available on LS

¹ Chevrolet Infotainment System functionality varies by model. Full functionality requires compatible Bluetooth and smartphone, and USB connectivity for some devices.

LT EXTERIOR COLORS



Summit White



Iridescent Pearl Tricoat¹



Satin Steel Metallic



Dark Ash Metallic



Empire Beige Metallic



Auburn Metallic



Cherry Red Tintcoat¹



Evergreen Gray Metallic



Midnight Blue Metallic



Black

¹Extra-cost color.

LT FEATURES



In addition to standard equipment, select LT features include:

MECHANICAL

Engine – 5.3L EcoTec3 V8 with Dynamic Fuel Management, Variable Valve Timing (VVT) and Direct Injection

Suspension – 4-wheel independent, Premium Smooth Ride

EXTERIOR

Assist steps – Black with chrome accent strip

Chevrolet bowtie emblems – Gold

Fascia – front lower, Black with bright chrome accent trim

Grille – Black with Black inserts and bright chrome accents and center bar

Liftgate – power, programmable, hands-free with Chevrolet emblem projection

Liftgate appliqué – bright chrome finish

Mirrors – heated, power-adjustable, manual-folding with body-color mirror caps

Roof rack side rails – bright

INTERIOR

Audio – Bose 9-speaker sound system

Console – with storage area and removable storage tray

Driver Information Center – 12-inch diagonal multi-color digital display with analog speedometer and tachometer

Entertainment – Chevrolet Infotainment 3 Premium system¹ with 10.2-inch diagonal HD color touch-screen and Google built-in² compatibility

Memory settings – recalls two presets for power driver seat

Seating – 8-passenger with front bucket seats and second- and third-row manual-folding 60/40 split-bench seats

Seats – driver and front passenger 10-way power adjusters with power lumbar control

Sill plates – front and rear, bright

Steering column – manual tilt and telescopic

Wireless charging³

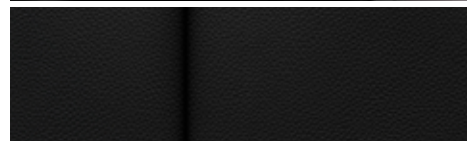

Jet Black Leather-Appointed Seating Surfaces⁴



Gideon Leather-Appointed Seating Surfaces⁴ (shown)



18" Bright Silver-Painted Aluminum Wheels (PZX)
Standard on LT



20" Painted-Aluminum Wheels with
Machined Face and Argent Metallic Pockets (RD4)
Available on LT

¹ Chevrolet Infotainment System functionality varies by model. Full functionality requires compatible Bluetooth and smartphone, and USB connectivity for some devices. ² Google built-in services are subject to limitations and availability may vary by vehicle, infotainment system and location. Select service plan required. Certain Google actions and functionality may require account linking. User terms and privacy statements apply. ³ The system wirelessly charges one compatible mobile device. Some phones have built-in wireless charging technology and others require a special adaptor/back cover. To check for phone or other device compatibility, see my.chevrolet.com/learn or consult your carrier. ⁴ Leather-appointed seating surfaces in front and second rows; third row is vinyl-covered.

RST EXTERIOR COLORS



Summit White



Iridescent Pearl Tricoat¹



Satin Steel Metallic



Dark Ash Metallic



Empire Beige Metallic



Auburn Metallic



Cherry Red Tintcoat¹



Evergreen Gray Metallic



Midnight Blue Metallic



Black

¹Extra-cost color.

RST FEATURES



In addition to standard equipment, select RST features include:

MECHANICAL

Engine – 5.3L EcoTec3 V8 with Dynamic Fuel Management, Variable Valve Timing (VVT) and Direct Injection

Suspension – 4-wheel independent, Premium Smooth Ride

EXTERIOR

Assist steps – Black with gloss Black accents

Chevrolet bowtie emblems – Black

Fascia – front lower, Black with gloss Black accent trim

Grille – Black with Black Ice chrome inserts, accents and center bar

Liftgate – power, programmable, hands-free with Chevrolet emblem projection

Liftgate appliqué – Black Ice chrome finish

Mirrors – heated, power-adjustable, manual-folding with body-color mirror caps

Roof rack side rails – Black

INTERIOR

Audio – Bose 9-speaker sound system

Console – with storage area and removable storage tray

Driver Information Center – 12-inch diagonal multi-color digital display with analog speedometer and tachometer

Entertainment – Chevrolet Infotainment 3 Premium system¹ with 10.2-inch diagonal HD color touch-screen and Google built-in² compatibility

Memory settings – recalls two presets for power driver seat

Seating – 8-passenger with front bucket seats and second- and third-row manual-folding 60/40 split-bench seats

Seats – driver and front passenger 10-way power adjusters with power lumbar control
– RST-specific

Steering column – manual tilt and telescopic

Wireless charging³



Jet Black Perforated Leather Seating Surfaces⁴ with Victory Red Stitching



22" Bright Machined High-Gloss Black-Painted Aluminum Wheels (SGF) with Wheel Locks Standard on RST

¹ Chevrolet Infotainment System functionality varies by model. Full functionality requires compatible Bluetooth and smartphone, and USB connectivity for some devices. ² Google built-in services are subject to limitations and availability may vary by vehicle, infotainment system and location. Select service plan required. Certain Google actions and functionality may require account linking. User terms and privacy statements apply. ³ The system wirelessly charges one compatible mobile device. Some phones have built-in wireless charging technology and others require a special adaptor/back cover. To check for phone or other device compatibility, see my.chevrolet.com/learn or consult your carrier. ⁴ Leather seating surfaces in front and second rows; third row is vinyl-covered.

Z71 EXTERIOR COLORS



Summit White



Iridescent Pearl Tricoat¹



Satin Steel Metallic



Dark Ash Metallic



Empire Beige Metallic



Auburn Metallic



Cherry Red Tintcoat¹



Evergreen Gray Metallic



Midnight Blue Metallic



Black

¹Extra-cost color.

Z71 FEATURES



In addition to standard equipment, select Z71 features include:

MECHANICAL

Air filter – heavy-duty

Engine – 5.3L EcoTec3 V8 with Dynamic Fuel Management, Variable Valve Timing (VVT) and Direct Injection

Hill Descent Control

Skid plate – front with Galvano finish

Transfer case – active, 2-speed electronic Autotrac, includes neutral position for dinghy towing

EXTERIOR

Assist steps – Black tubular

Chevrolet bowtie emblems – Black

Fascia – front lower, high approach angle, gloss Black

Grille – Black mesh with Black Ice chrome center bar and unique Z71 badging

Liftgate – power, programmable, hands-free with Chevrolet emblem projection

Liftgate appliqué – Black Ice chrome finish

Mirrors – heated, power-adjustable, manual-folding with body-color mirror caps

Recovery hooks¹ – Red

Roof rack side rails – Black

INTERIOR

Audio – Bose 9-speaker sound system

Driver Information Center – 12-inch diagonal multi-color digital display with analog speedometer and tachometer

Entertainment – Chevrolet Infotainment 3 Premium system² with 10.2-inch diagonal HD color touch-screen and Google built-in³ compatibility

Memory settings – recalls two presets for power driver seat

Seats – driver and front passenger 10-way power adjusters with power lumbar control

Wireless charging⁴

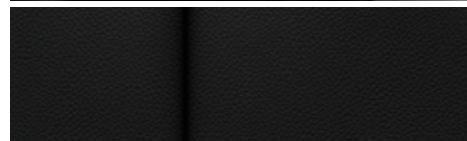

Jet Black Leather-Appointed Seating Surfaces⁵



Gideon Leather-Appointed Seating Surfaces⁵ (shown)



20" Machined-Aluminum Wheels with Technical Gray Pockets (NZU) Standard on Z71

¹ To avoid the risk of injury, never use recovery hooks to tow a vehicle. For more information, see the Recovery Hooks section of your Owner's Manual. ² Chevrolet Infotainment System functionality varies by model. Full functionality requires compatible Bluetooth and smartphone, and USB connectivity for some devices. ³ Google built-in services are subject to limitations and availability may vary by vehicle, infotainment system and location. Select service plan required. Certain Google actions and functionality may require account linking. User terms and privacy statements apply. ⁴ The system wirelessly charges one compatible mobile device. Some phones have built-in wireless charging technology and others require a special adaptor/back cover. To check for phone or other device compatibility, see my.chevrolet.com/learn or consult your carrier. ⁵ Leather-appointed seating surfaces in front and second rows; third row is vinyl-covered.

PREMIER EXTERIOR COLORS



Summit White



Iridescent Pearl Tricoat¹



Satin Steel Metallic



Dark Ash Metallic



Empire Beige Metallic



Auburn Metallic



Cherry Red Tintcoat¹



Evergreen Gray Metallic



Midnight Blue Metallic



Black

¹Extra-cost color.

PREMIER FEATURES



In addition to standard equipment, select Premier features include:

MECHANICAL

Engine – 5.3L EcoTec3 V8 with Dynamic Fuel Management, Variable Valve Timing (VVT) and Direct Injection

Exhaust – dual system with dual twin polished stainless steel tips

Suspension – 4-wheel independent, Magnetic Ride Control

EXTERIOR

Fascia – front lower, Black with bright chrome accent trim

Grille – Black with bright chrome inserts and Galvano accents and bright chrome center bar

Liftgate – power, programmable, hands-free with Chevrolet emblem projection

Mirrors – heated, power-adjustable, power-folding with memory and driver-side auto-dimming features, integrated turn signal indicators and puddle lamps; chrome mirror caps

INTERIOR

Audio – Bose 10-speaker surround sound system with Centerpoint

Driver Information Center – 12-inch diagonal multi-color digital display with analog speedometer and tachometer

Entertainment – Chevrolet Infotainment 3 Premium system¹ with 10.2-inch diagonal HD color touch-screen and Google built-in² compatibility

Lane Change Alert with Side Blind Zone Alert³

Memory settings – recalls two presets for power driver seat, outside rearview mirrors, and power tilt and telescopic steering column

Rear Cross Traffic Alert³

Safety Alert Seat³

Seating – 7-passenger with front bucket seats, second-row bucket seats with power-release and third-row power-folding 60/40 split-bench seat

Seats – driver and front passenger 10-way power adjusters with power lumbar control

Steering column – power tilt and telescopic

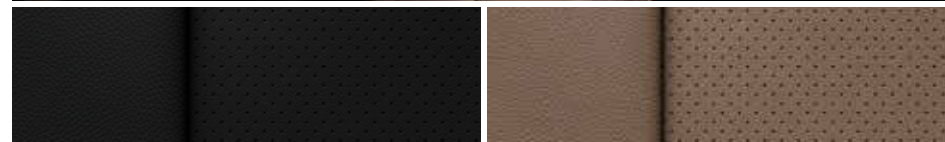

Jet Black Perforated Leather Seating Surfaces⁴

Maple Sugar Perforated Leather Seating Surfaces⁴ (shown)



20" Polished-Finish Aluminum Wheels (RD2)
Standard on Premier



22" Polished-Aluminum Wheels (RVA)
with Wheel Locks
Available on Premier

¹ Chevrolet Infotainment System functionality varies by model. Full functionality requires compatible Bluetooth and smartphone, and USB connectivity for some devices. ² Google built-in services are subject to limitations and availability may vary by vehicle, infotainment system and location. Select service plan required. Certain Google actions and functionality may require account linking. User terms and privacy statements apply. ³ Safety or driver assistance features are no substitute for the driver's responsibility to operate the vehicle in a safe manner. Read the vehicle Owner's Manual for important feature limitations and information. ⁴ Leather seating surfaces in front and second rows; third row is vinyl-covered.

HIGH COUNTRY EXTERIOR COLORS



Summit White



Iridescent Pearl Tricoat¹



Satin Steel Metallic



Dark Ash Metallic



Empire Beige Metallic



Auburn Metallic



Cherry Red Tintcoat¹



Evergreen Gray Metallic



Midnight Blue Metallic



Black

¹Extra-cost color.

HIGH COUNTRY FEATURES



In addition to standard equipment, select High Country features include:

MECHANICAL

Engine – 6.2L EcoTec3 V8 with Dynamic Fuel Management, Variable Valve Timing (VVT) and Direct Injection

Exhaust – dual system with dual twin polished stainless steel tips

Suspension – 4-wheel independent, Magnetic Ride Control

EXTERIOR

Fascia – front lower, Black with Galvano accent

Grille – Black with Galvano inserts and Godric accents and Galvano center bar

Liftgate – power, programmable, hands-free with Chevrolet emblem projection

Mirrors – heated, power-adjustable, power-folding with memory and driver-side auto-dimming features, integrated turn signal indicators and puddle lamps; body-color mirror caps

INTERIOR

Audio – Bose 10-speaker surround sound system with Centerpoint

Driver Information Center – 12-inch diagonal multi-color digital display with analog speedometer and tachometer

Entertainment – Chevrolet Infotainment 3 Premium system¹ with 10.2-inch diagonal HD color touch-screen and Google built-in² compatibility

Head-Up Display – 15-inch diagonal multi-color display

Lane Change Alert with Side Blind Zone Alert³

Memory settings – recalls two presets for power driver seat, outside rearview mirrors, and power tilt and telescopic steering column

Rear Camera Mirror³ with washer – auto-dimming

Rear Cross Traffic Alert³

Rear Pedestrian Alert³

Safety Alert Seat³

Seating – 7-passenger with front bucket seats, second-row bucket seats with power-release and third-row power-folding 60/40 split-bench seat

Seats – heated and ventilated driver and front passenger

HD Surround Vision³ – includes HD Rear Vision Camera³



Jet Black Perforated Leather Seating Surfaces⁴

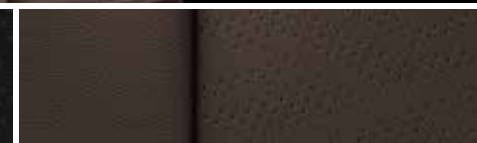

Mocha Perforated Leather Seating Surfaces⁴ (shown)



22" Sterling Silver-Painted Aluminum Wheels with Chrome Inserts (RPT) with Wheel Locks Standard on High Country

¹ Chevrolet Infotainment System functionality varies by model. Full functionality requires compatible Bluetooth and smartphone, and USB connectivity for some devices. ² Google built-in services are subject to limitations and availability may vary by vehicle, infotainment system and location. Select service plan required. Certain Google actions and functionality may require account linking. User terms and privacy statements apply. ³ Safety or driver assistance features are no substitute for the driver's responsibility to operate the vehicle in a safe manner. Read the vehicle Owner's Manual for important feature limitations and information. ⁴ Leather seating surfaces in front and second rows; third row is vinyl-covered.

Some features shown may have limited, late or no availability. See dealer for feature availability.

SPECIFICATIONS

● STANDARD ○ AVAILABLE – NOT AVAILABLE

	LS	LT	RST	Z71	PREMIER	HIGH COUNTRY
SAFETY AND DRIVER ASSISTANCE						
Chevy Safety Assist ¹	●	●	●	●	●	●
Automatic Emergency Braking	●	●	●	●	●	●
Front Pedestrian Braking	●	●	●	●	●	●
Lane Keep Assist with Lane Departure Warning	●	●	●	●	●	●
Forward Collision Alert	●	●	●	●	●	●
IntelliBeam, auto high beams	●	●	●	●	●	●
Following Distance Indicator	●	●	●	●	●	●
Airbags ² – frontal airbags for driver and front outboard passenger; seat-mounted side-impact airbags for driver and front outboard passenger; driver inboard seat-mounted side-impact airbag (requires front bucket seats on LS); head-curtain airbags for all rows in outboard seating positions; includes front outboard Passenger Sensing System for frontal outboard passenger airbag	●	●	●	●	●	●
Buckle to Drive	●	●	●	●	●	●
Enhanced Automatic Emergency Braking ¹ (requires available Adaptive Cruise Control ¹)	–	–	–	–	○	○
Front and Rear Park Assist ¹ (feature will not function on certain models without dealer retrofit; see dealer or window label for details)	○	○	○	○	○	○
Lane Change Alert with Side Blind Zone Alert ¹ (requires available Driver Alert Package on LS, LT, RST and Z71)	○	○	○	○	●	●
LATCH system (Lower Anchors and Tethers for CHildren) – for child restraint systems	●	●	●	●	●	●
Rear Cross Traffic Alert ¹ (requires available Driver Alert Package on LS, LT, RST and Z71)	○	○	○	○	●	●
Rear Pedestrian Alert ¹ (requires available Luxury Package on LT, RST and Z71; requires available Enhanced Display and Alert Package on Premier)	–	○	○	○	○	●
HD Rear Vision Camera ¹	●	●	●	●	●	–
HD Surround Vision ¹ – includes HD Rear Vision Camera ¹ (requires available Luxury Package on LT, RST and Z71; requires available Enhanced Display and Alert Package on Premier)	–	○	○	○	○	●
Reverse Automatic Braking ¹ (requires available Enhanced Display and Alert Package and Adaptive Cruise Control on Premier; requires available Adaptive Cruise Control on High Country)	–	–	–	–	○	○
Safety Alert Seat ¹	–	–	–	–	●	●
Teen Driver technology ¹	●	●	●	●	●	●
Theft-deterrent system – unauthorized entry	●	●	●	●	●	●
Tire Pressure Monitoring System – with Tire Fill Alert (does not monitor spare tire)	●	●	●	●	●	●
Trailer Side Blind Zone Alert ¹ (requires available Advanced Trailing Package)	–	–	–	–	○	○
Up to 3 months of OnStar [®] Safety & Security coverage ³	●	●	●	●	●	●

	LS	LT	RST	Z71	PREMIER	HIGH COUNTRY
MECHANICAL						
Air filter – heavy-duty	–	–	–	●	–	–
– engine air filtration monitor	●	●	●	●	●	●
Alternator – 220 amps; included with V8 engine	●	●	●	●	●	●
– 250 amps; included with Duramax 3.0L Turbo-Diesel I-6 engine	○	○	○	–	○	○
Brakes – 4-wheel antilock, 4-wheel disc with Duralife rotors	●	●	●	●	●	●
Cooling – external engine and transmission oil coolers (engine oil cooler not available with Duramax 3.0L Turbo-Diesel I-6 engine)	●	●	●	●	●	●
– extra-capacity (requires available Max Trailing Package; not available with Duramax 3.0L Turbo-Diesel I-6 engine)	○	○	○	○	○	○
Differential – mechanical limited-slip	●	●	●	●	●	●
– electronic Limited-Slip (eLSD) (requires available Off-Road Capability Package, Max Trailing Package and Luxury Package)	–	–	–	○	–	–
Engine – 5.3L EcoTec3 V8 (L84) equipped with Dynamic Fuel Management, Variable Valve Timing, Direct Injection and Automatic Stop/Start; 355 hp @ 5600 rpm, 383 lb.-ft. of torque @ 4100 rpm	○	○	○	○	○	–
– 5.3L EcoTec3 V8 (L84/NSS ⁴) equipped with Dynamic Fuel Management, Variable Valve Timing and Direct Injection; not equipped with Automatic Stop/Start; 355 hp @ 5600 rpm, 383 lb.-ft. of torque @ 4100 rpm	○	○	○	○	○	–
Engine – 6.2L EcoTec3 V8 (L87) equipped with Dynamic Fuel Management, Variable Valve Timing, Direct Injection and Automatic Stop/Start (requires available Sport Performance Package on RST; requires available Off-Road Performance Package, Off-Road Capability Package, Max Trailing Package and Luxury Package on Z71); 420 hp @ 5600 rpm, 460 lb.-ft. of torque @ 4100 rpm	–	–	○	○	○	○
– 6.2L EcoTec3 V8 (L87/NSS ⁴) equipped with Dynamic Fuel Management, Variable Valve Timing and Direct Injection; not equipped with Automatic Stop/Start (requires available Sport Performance Package on RST; requires available Off-Road Performance Package, Off-Road Capability Package, Max Trailing Package and Luxury Package on Z71); 420 hp @ 5600 rpm, 460 lb.-ft. of torque @ 4100 rpm	–	–	○	○	○	○
Engine – Duramax 3.0L Turbo-Diesel I-6 (LM2) with common rail Direct Injection and Diesel Exhaust Brake System; 277 hp @ 3750 rpm, 460 lb.-ft. of torque @ 1500 rpm; includes engine block heater and upper and lower active aero shutters	○	○	○	–	○	○
Exhaust – single system with single-outlet (requires available Duramax 3.0L Turbo-Diesel I-6 engine on Premier and High Country)	●	●	●	●	○	○
– dual system with dual twin polished stainless steel tips (deleted when available Duramax 3.0L Turbo-Diesel I-6 engine is ordered on Premier and High Country; requires available Sport Performance Package on RST; requires available Off-Road Performance Package, Off-Road Capability Package, Max Trailing Package and Luxury Package on Z71)	–	–	○	○	●	●

¹ Safety or driver assistance features are no substitute for the driver's responsibility to operate the vehicle in a safe manner. Read the vehicle Owner's Manual for important feature limitations and information. ² A NOTE ON CHILD SAFETY: Always use seat belts and the correct child restraint for your child's age and size, even with airbags. Even in vehicles equipped with the Passenger Sensing System, children are safer when properly secured in a rear seat in the appropriate infant, child or booster seat. Never place a rear-facing infant restraint in the front seat of any vehicle equipped with an active frontal airbag. See your vehicle Owner's Manual and the child safety seat instructions for more safety information. ³ When you select a monthly plan within 30 days of activating your 1-month trial, you'll receive the next 2 months of the plan you select at no additional charge when you associate an approved payment method on file to your account and authorize recurring payments for your service plan. The amount and frequency of each recurring payment is based upon the service(s) and payment interval(s) you select from the options provided. After the trial expires, OnStar will automatically bill your payment method monthly at then-current standard monthly rates. Plans containing 4G LTE data will be billed every 30 days by AT&T. You may cancel at any time by pushing your blue OnStar button or calling 1-888-466-7827. May not be combined with other offers or retroactively applied. Offer subject to change. ⁴ Most vehicles built between October 2021 and December 12, 2021, equipped with a V8 engine are not equipped with Automatic Stop/Start and its content. Contact a dealer for details on a specific vehicle. Vehicles not equipped with Automatic Stop/Start will be less fuel efficient. Please see page 25 for details.

SPECIFICATIONS (CONTINUED)

● STANDARD ○ AVAILABLE – NOT AVAILABLE

	LS	LT	RST	Z71	PREMIER	HIGH COUNTRY
MECHANICAL (CONTINUED)						
Hill Descent Control (requires available 4WD on Premier and High Country)	–	–	–	●	○	○
Hitch Guidance ¹	●	●	●	●	●	●
Hitch Guidance with Hitch View ¹ – image adjustment and pan/zoom (requires available Advanced Trailing Package and Max Trailing Package)	–	○	○	○	○	○
Skid plate – front with Galvano finish	–	–	–	○	–	–
Smart Trailer Integration Indicator (requires available Advanced Trailing Package)	–	○	○	○	○	○
StabiliTrak – Electronic Stability Control System and Traction Control; includes Electronic Trailer Sway Control and Hill Start Assist	●	●	●	●	●	●
Steering – rack-and-pinion with electric assist	●	●	●	●	●	●
Suspension – 4-wheel independent, front coil-over-shock and rear multi-link with coil springs	●	●	●	●	●	●
– Premium Smooth Ride	●	●	●	●	–	–
– Magnetic Ride Control (requires available Sport Performance Package on RST; requires available Off-Road Performance Package, Off-Road Capability Package, Max Trailing Package and Luxury Package on Z71)	–	–	○	○	●	●
– Air Ride Adaptive (requires available Off-Road Capability Package, Max Trailing Package and Luxury Package or Z71 Off-Road Package on Z71; requires available Max Trailing Package on High Country)	–	–	–	○	–	○
Trailer brake controller – integrated (requires available Advanced Trailing Package and Max Trailing Package)	○	○	○	○	○	○
Trailer Tire Pressure Monitor sensors – four sensors (requires available LT Signature Package or Max Trailing Package on LT; requires available Max Trailing Package on RST; requires available Z71 Off-Road Package or Max Trailing Package on Z71; requires available Premium Package or Max Trailing Package on Premier; requires available Premium Package, High Country Deluxe or Max Trailing Package on High Country)	–	○	○	○	○	○
Trailer View ¹ – enhanced, includes trailer camera provisions, trailing assist guidelines and dealer-installed auxiliary trailer camera (requires available Max Trailing Package, Trailer Tire Pressure Monitor sensors and Enhanced Display and Alert Package on Premier; requires available Max Trailing Package and Trailer Tire Pressure Monitor sensors on High Country)	–	–	–	–	○	○
Trailing equipment – trailer hitch platform, 7-wire harness with independent fused trailing circuits mated to a 7-way sealed connector, 2-inch trailing receiver and Hitch Guidance ¹	●	●	●	●	●	●
Transfer case – active, single-speed electronic Autotrac; does not include neutral position for dinghy towing (requires available 4WD)	○	○	○	–	–	–
– active, 2-speed electronic Autotrac; includes neutral position for dinghy towing (requires available 4WD and Max Trailing Package on LS, LT and RST; requires available 4WD on Premier and High Country)	○	○	○	●	○	○
Transmission – 10-speed automatic, electronically controlled with overdrive and Electronic Precision Shift; includes Traction Select System and Tow/Haul mode	●	●	●	●	●	●

	LS	LT	RST	Z71	PREMIER	HIGH COUNTRY
EXTERIOR						
Active aero shutters – upper; included with V8 engine	●	●	●	●	●	●
– upper and lower; included with Duramax 3.0L Turbo-Diesel I-6 engine	○	○	○	–	○	○
Assist steps – Black with chrome accent strip	●	●	–	–	●	●
– Black with gloss Black accents	–	–	●	–	–	–
– Black tubular	–	–	–	●	–	–
– power-retractable with perimeter lighting	–	–	–	–	○	○
Chevrolet bowtie emblems – Gold	●	●	–	–	●	●
– Black	–	–	●	●	–	–
Daytime running lamps – LED	●	●	●	●	●	●
Door handles – body-color	●	●	●	●	–	–
– chrome with body-color strip	–	–	–	–	●	●
Fascia – front lower, Black with bright chrome accent trim	●	●	–	–	●	–
– front lower, Black with gloss Black accent trim	–	–	●	–	–	–
– front lower, high approach angle, gloss Black	–	–	–	●	–	–
– front lower, Black with Galvano accent	–	–	–	–	–	●
Fuel filler – capless fueling	●	●	●	●	●	●
Glass – solar-absorbing with acoustic-laminated windshield and deep-tinted rear windows	●	●	●	●	●	●
Grille – Black mesh with bright chrome center bar	●	–	–	–	–	–
– Black with Black inserts and bright chrome accents and center bar	–	●	–	–	–	–
– Black with Black Ice chrome inserts, accents and center bar	–	–	●	–	–	–
– Black mesh with Black Ice chrome center bar and unique Z71 badging	–	–	–	●	–	–
– Black with bright chrome inserts and Galvano accents and bright chrome center bar	–	–	–	–	●	–
– Black with Galvano inserts and Godric accents and Galvano center bar	–	–	–	–	–	●
Headlamps – LED, automatic on/off with automatic delay	●	●	●	●	●	●
Liftgate – manual	●	–	–	–	–	–
– power, programmable, hands-free with Chevrolet emblem projection	–	●	●	●	●	●
Liftgate appliqué – bright chrome finish	●	●	–	–	●	–
– Black Ice chrome finish	–	–	●	●	–	–
– Galvano finish	–	–	–	–	–	●
Mirror caps – body-color	●	●	●	●	–	●
– chrome	–	–	–	–	●	–
Mirrors – heated, power-adjustable, manual-folding	●	●	●	●	–	–
– heated, power-adjustable, power-folding with memory and driver-side auto-dimming features, integrated turn signal indicators and puddle lamps (requires available Luxury Package on LT, RST and Z71)	–	○	○	○	●	●

¹ Safety or driver assistance features are no substitute for the driver's responsibility to operate the vehicle in a safe manner. Read the vehicle Owner's Manual for important feature limitations and information.

SPECIFICATIONS (CONTINUED)

● STANDARD ○ AVAILABLE – NOT AVAILABLE

	LS	LT	RST	Z71	PREMIER	HIGH COUNTRY
EXTERIOR (CONTINUED)						
Recovery hooks ¹ – Red	–	–	–	●	–	–
Roof rack side rails – bright	●	●	–	–	●	●
– Black	–	–	●	●	–	–
Taillamps – LED	●	●	●	●	●	●
Tire – 17" full-size spare, lockable, mounted under frame at rear	●	●	●	●	●	●
Tires – 265/65R18SL all-season	●	●	–	–	–	–
– 275/60R20SL all-terrain	–	–	–	●	–	–
– 275/60R20SL all-season (requires available 20" painted-aluminum wheels with machined face and Argent Metallic pockets [RD4] on LS and LT)	○	○	–	–	●	–
– 275/50R22SL all-season (requires available 22" polished-aluminum wheels [RVA] on Premier)	–	–	●	–	○	●
Wheels – 18" Bright Silver-painted aluminum (PZX)	●	●	–	–	–	–
– 20" painted-aluminum with machined face and Argent Metallic pockets (RD4)	○	○	–	–	–	–
– 20" machined-aluminum with Technical Gray pockets (NZU)	–	–	–	●	–	–
– 20" polished-finish aluminum (RD2)	–	–	–	–	●	–
– 22" bright machined high-gloss Black-painted aluminum (SGF) with wheel locks	–	–	●	–	–	–
– 22" polished-aluminum (RVA) with wheel locks	–	–	–	–	○	–
– 22" Sterling Silver-painted aluminum with chrome inserts (RPT) with wheel locks	–	–	–	–	–	●
Wipers – front variable-speed, intermittent with Rainsense; rear intermittent with washer	●	●	●	●	●	●
INTERIOR						
Air conditioning – tri-zone automatic climate controls, with individual climate settings for driver, right-front passenger and rear passengers	●	●	●	●	●	●
– rear air conditioning	●	●	●	●	●	●
Assist handles – overhead, driver and front passenger	●	●	●	●	●	●
– front passenger A-pillar and second-row outboard B-pillar	●	●	●	●	●	●
Cargo area – Cargo Management System	●	●	●	●	●	●
Console – with storage area and removable storage tray (included on Premier and High Country models built on or after January 10, 2022)	●	●	●	●	○	○
– power-sliding center console with drawer, secure storage, manual-sliding armrest and cup holders for second row (requires available Luxury Package and second-row bucket seats on LT, RST and Z71; not included with available second-row power-release folding 60/40 split-bench seat on Premier and High Country; limited availability)	–	○	○	○	○	○
Cruise control – electronic with Set and Resume Speed	●	●	●	●	●	●
– Adaptive Cruise Control ² with Enhanced Automatic Emergency Braking ² (requires available Enhanced Display and Alert Package on Premier)	–	–	–	–	○	○

	LS	LT	RST	Z71	PREMIER	HIGH COUNTRY
INTERIOR (CONTINUED)						
Defogger – electric rear-window	●	●	●	●	●	●
Door locks – power programmable with lockout protection and manual rear door child security	●	●	●	●	●	●
Driver Information Center – 4.2-inch diagonal color display, includes driver personalization	●	–	–	–	–	–
– 12-inch diagonal multi-color digital display with analog speedometer and tachometer	–	●	●	●	●	●
Floor mats – front and second-row carpeted	●	●	●	●	●	●
Head-Up Display – 15-inch diagonal multi-color (requires available Enhanced Display and Alert Package on Premier)	–	–	–	–	○	●
Keyless Open and Start – includes extended-range Remote Keyless Entry	●	●	●	●	●	●
Lighting – interior lighting with door handle or Remote Keyless Entry-activated illuminated entry, cargo area, and front and second-row reading lamps	●	●	●	●	●	●
Memory settings – recalls two presets for power driver seat	–	●	●	●	–	–
– recalls two presets for power driver seat, outside rearview mirrors, and power tilt and telescopic steering column (requires available Luxury Package on LT, RST and Z71)	–	○	○	○	●	●
Mirror – rearview, manual day/night	●	–	–	–	–	–
– rearview, auto-dimming	–	●	●	●	●	–
– Rear Camera Mirror ² with washer; auto-dimming (requires available Enhanced Display and Alert Package on Premier)	–	–	–	–	○	●
Power outlets – three, one 12-volt in center stack, one 120-volt on rear of center console and one 120-volt in cargo area	●	●	●	●	●	●
Rear Seat Reminder ³	●	●	●	●	●	●
Remote vehicle starter system	●	●	●	●	●	●
Sill plates – front and rear, bright (High Country includes specific logo)	–	●	●	●	●	●
Steering column – manual tilt and telescopic	●	●	●	●	–	–
– power tilt and telescopic (requires available Luxury Package on LT, RST and Z71)	–	○	○	○	●	●
Steering wheel – leather-wrapped with mounted audio, cruise, phone and Driver Information Center controls	●	●	●	●	●	●
– heated, automatic (requires available Luxury Package on LT, RST and Z71; feature will not function on certain models without dealer retrofit; see dealer or window label for details)	–	○	○	○	○	●
Sunroof – panoramic power, dual-pane with power sunshade	–	○	○	○	○	○
Universal Home Remote – programmable, includes garage door opener	–	●	●	●	●	●
Visors – driver and front passenger, covered illuminated vanity mirrors, sliding	●	●	●	●	●	●
Windows – power with driver and front passenger express-up/-down, all others express-down	●	●	●	●	●	●

¹ To avoid the risk of injury, never use recovery hooks to tow a vehicle. For more information, see the Recovery Hooks section of your Owner's Manual. ² Safety or driver assistance features are no substitute for the driver's responsibility to operate the vehicle in a safe manner. Read the vehicle Owner's Manual for important feature limitations and information. ³ Does not detect people or items. Always check rear seat before exiting.

SPECIFICATIONS (CONTINUED)

● STANDARD ○ AVAILABLE – NOT AVAILABLE

	LS	LT	RST	Z71	PREMIER	HIGH COUNTRY
SEATING						
Seating – 8-passenger with front bucket seats, second-row folding 60/40 split-bench seat and third-row folding 60/40 split-bench seat (requires available Jet Black interior on High Country)	●	●	●	●	○	○
– 9-passenger with front 40/20/40 split-bench seat (deletes driver inboard seat-mounted side-impact airbag; center floor console and USB ports ²), second-row folding 60/40 split-bench seat and third-row folding 60/40 split-bench seat	○	–	–	–	–	–
– 7-passenger with front bucket seats, second-row bucket seats and third-row folding 60/40 split-bench seat	–	○	○	○	●	●
Seats – second-row 60/40 split-bench, manual-folding	●	●	●	●	–	–
– second-row folding 60/40 split-bench, power-release (requires available Luxury Package on LT, RST and Z71; requires available Jet Black interior on High Country)	–	○	○	○	○	○
– second-row bucket, manual-release	–	○	–	○	–	–
– second-row bucket, power-release (requires available LT Signature Package, LT Signature Plus Package or Luxury Package on LT; requires available Luxury Package on RST; requires available Z71 Off-Road Package or Luxury Package on Z71)	–	○	○	○	●	●
– third-row 60/40 split-bench, manual-folding	●	●	●	●	–	–
– third-row 60/40 split-bench, power-folding (requires available Luxury Package on LT, RST and Z71)	–	○	○	○	●	●
Seat – driver 10-way power adjuster with power lumbar control	●	●	●	●	●	●
– front passenger 8-way power adjuster with power lumbar control	●	–	–	–	–	–
– front passenger 10-way power adjuster with power lumbar control	–	●	●	●	●	●
Heated seats – driver and front passenger (feature will not function on certain models without dealer retrofit; see dealer or window label for details)	–	○	○	○	–	–
Heated and ventilated seats – driver and front passenger (feature will not function on certain models without dealer retrofit; see dealer or window label for details)	–	–	–	–	○	●
Heated second-row outboard seating positions (requires available Luxury Package on LT, RST and Z71; feature will not function on certain models without dealer retrofit; see dealer or window label for details)	–	○	○	○	○	○

	LS	LT	RST	Z71	PREMIER	HIGH COUNTRY
ENTERTAINMENT						
Chevrolet Infotainment 3 system ³ with 8-inch diagonal color touch-screen, AM/FM stereo, Bluetooth [®] audio streaming ⁴ for two active devices and wireless Apple CarPlay ^{®5} and wireless Android Auto ^{™6} compatibility	●	–	–	–	–	–
Chevrolet Infotainment 3 Premium system ³ with 10.2-inch diagonal HD color touch-screen and Google built-in ⁷ compatibility, AM/FM stereo, Bluetooth audio streaming ⁴ for two active devices, wireless Apple CarPlay ⁵ and wireless Android Auto ⁶ compatibility, voice recognition and available In-Vehicle Apps ⁸	–	●	●	●	●	●
Audio – 6-speaker system	●	–	–	–	–	–
– Bose 9-speaker sound system	–	●	●	●	–	–
– Bose 10-speaker surround sound system with Centerpoint	–	–	–	–	●	●
Media – two USB ports ² on center stack, two USB ports ² in center console, two USB ports ² in second row on rear of center console, and two USB ports ² in third row	●	●	●	●	●	●
Rear-Seat Media System – dual rear seat-mounted 12.6-inch diagonal LCD HD color touch-screens, Wi-Fi [®] wireless projection capability, two Bluetooth headphones and two HDMI ports on rear of center console	–	○	○	○	○	○
SiriusXM [®] with 360L ⁹ – 3-month trial subscription	●	●	●	●	●	●
Available Wi-Fi Hotspot ¹⁰ for up to seven devices, includes 1 month of unlimited data	○	○	○	○	○	○
Chevrolet Connected Access ¹¹ with up to 10 years of standard connectivity, which currently enables features such as Vehicle Diagnostics and Dealer Maintenance Notification	●	●	●	●	●	●
Wireless charging ¹²	–	●	●	●	●	●

1 A NOTE ON CHILD SAFETY: Always use seat belts and the correct child restraint for your child's age and size, even with airbags. Even in vehicles equipped with the Passenger Sensing System, children are safer when properly secured in a rear seat in the appropriate infant, child or booster seat. Never place a rear-facing infant restraint in the front seat of any vehicle equipped with an active frontal airbag. See your vehicle Owner's Manual and the child safety seat instructions for more safety information.

2 Not compatible with all devices. **3** Chevrolet Infotainment System functionality varies by model. Full functionality requires compatible Bluetooth and smartphone, and USB connectivity for some devices. **4** Go to my.chevrolet.com/learnAbout/bluetooth to find out which phones are compatible with the vehicle. Full Bluetooth feature functionality varies by device, model and software version. **5** Vehicle user interface is a product of Apple and its terms and privacy statements apply. Requires compatible iPhone and data plan rates apply. **6** Vehicle user interface is a product of Google and its terms and privacy statements apply. To use Android Auto on your car display, you'll need an Android phone running Android 6 or higher, an active data plan, and the Android Auto app. **7** Google built-in services are subject to limitations and availability may vary by vehicle, infotainment system and location. Select service plan required. Certain Google actions and functionality may require account linking. User terms and privacy statements apply. **8** Third-party trademarks are the property of their respective third-party owners and used under agreement. Requires active service plan and paid AT&T vehicle data plan. Visit onstar.com for details and limitations. **9** If you decide to continue service after your trial, your selected subscription plan will automatically renew thereafter. You will be charged at then-current rates. Fees and taxes apply. To cancel you must call SiriusXM at 1-866-635-2349. See SiriusXM Customer Agreement for complete terms at siriusxm.com. All fees and programming subject to change. Certain features require a SiriusXM subscription and the Chevrolet Connected Access plan. See siriusxm.com and onstar.com for details and limitations. **10** Service varies with conditions and location. Requires active service and paid AT&T data plan. Visit onstar.com for details and limitations. Availability subject to change. **11** Standard connectivity available only to original purchaser for up to 10 years. Connected Access services are subject to change. Does not include emergency or security services. Diagnostic capabilities vary by model and service plan. Message and data rates may apply. Requires contact method on file and enrollment to receive alerts. Not all issues will deliver alerts. Visit onstar.com for details and limitations. **12** The system wirelessly charges one compatible mobile device. Some phones have built-in wireless charging technology and others require a special adaptor/back cover. To check for phone or other device compatibility, see my.chevrolet.com/learn or consult your carrier.

AVAILABLE PACKAGES

● STANDARD ○ AVAILABLE – NOT AVAILABLE

	LS	LT	RST	Z71	PREMIER	HIGH COUNTRY
MECHANICAL						
Advanced Trailering Package	○	○	○	○	○	○
Hitch Guidance with Hitch View ¹ ; integrated trailer brake controller and Smart Trailer Integration Indicator; includes Trailer Side Blind Zone Alert ¹ on Premier and High Country; Hitch Guidance with Hitch View and Smart Trailer Integration Indicator not included on LS (requires available Max Trailering Package)						
Max Trailering Package	○	○	○	○	○	○
Advanced Trailering Package and extra-capacity cooling system; includes Autotrac 2-speed active transfer case on LS, LT and RST 4WD models (extra-capacity cooling system not included with available Duramax 3.0L Turbo-Diesel I-6 engine)						
Sport Performance Package	–	–	○	–	–	–
6.2L EcoTec3 V8 engine, Magnetic Ride Control suspension and dual exhaust system with dual twin polished stainless steel tips						
Off-Road Capability Package	–	–	–	○	–	–
Magnetic Ride Control suspension, Air Ride Adaptive suspension and electronic Limited-Slip Differential (eLSD) (requires available Max Trailering Package and Luxury Package)						
Off-Road Performance Package	–	–	–	○	–	–
6.2L EcoTec3 V8 engine and dual exhaust system with dual twin polished stainless steel tips (requires available Off-Road Capability Package, Max Trailering Package and Luxury Package)						
INTERIOR						
Driver Alert Package¹	○	○	○	○	–	–
Lane Change Alert with Side Blind Zone Alert and Rear Cross Traffic Alert (requires available Luxury Package on LT, RST and Z71)						
Luxury Package	–	○	○	○	–	–
Driver Alert Package, HD Surround Vision ¹ ; Rear Pedestrian Alert ¹ ; memory settings, outside heated power-adjustable power-folding mirrors with memory, driver-side auto-dimming feature and integrated turn signal indicators, power tilt and telescopic steering column, second-row folding 60/40 split-bench seat with power-release, third-row power-folding 60/40 split-bench seat, second-row outboard heated seats (feature will not function on certain models without dealer retrofit; see dealer or window label for details) and automatic heated steering wheel (feature will not function on certain models without dealer retrofit; see dealer or window label for details)						

	LS	LT	RST	Z71	PREMIER	HIGH COUNTRY
INTERIOR (CONTINUED)						
LT Signature Package	–	○	–	–	–	–
Luxury Package, Max Trailering Package, 20" painted-aluminum wheels with machined face and Argent Metallic pockets (RD4), 275/60R20SL all-season tires and panoramic dual-pane power sunroof						
LT Signature Plus Package	–	○	–	–	–	–
Luxury Package, 20" painted-aluminum wheels with machined face and Argent Metallic pockets (RD4), 275/60R20SL all-season tires and panoramic dual-pane power sunroof						
Texas Edition	–	○	–	–	○	–
Texas Edition badging; includes 22" polished-aluminum wheels (RVA) and 275/50R22SL all-season tires on Premier (requires available LT Signature Package, LT Signature Plus Package or Luxury Package on LT)						
Z71 Off-Road Package	–	–	–	○	–	–
Luxury Package, Max Trailering Package and Off-Road Capability Package						
Enhanced Display and Alert Package	–	–	–	–	○	–
HD Surround Vision ¹ ; Head-Up Display, Rear Camera Mirror ¹ with washer and Rear Pedestrian Alert ¹						
Premium Package	–	–	–	–	○	○
Max Trailering Package, panoramic dual-pane power sunroof and Adaptive Cruise Control ¹ ; includes Enhanced Display and Alert Package on Premier; includes power-retractable assist steps with perimeter lighting on High Country						
Premium Package 2	–	–	–	–	○	○
Panoramic dual-pane power sunroof and Adaptive Cruise Control ¹ ; includes Enhanced Display and Alert Package on Premier; includes power-retractable assist steps with perimeter lighting on High Country						
High Country Deluxe	–	–	–	–	–	○
Max Trailering Package, Air Ride Adaptive suspension, panoramic dual-pane power sunroof, Adaptive Cruise Control ¹ and power-retractable assist steps with perimeter lighting						

¹ Safety or driver assistance features are no substitute for the driver's responsibility to operate the vehicle in a safe manner. Read the vehicle Owner's Manual for important feature limitations and information.

SPECIFICATIONS (CONTINUED)

MAXIMUM CAPACITIES

Fuel tank (approximate)	24 gallons
Seating	LS: seats 8, option for 9 LT, RST and Z71: seats 8, option for 7 Premier and High Country: seats 7, option for 8
Cargo volume ¹	Behind third-row seat: 25.5 cu. ft. With third-row seat folded: 72.6 cu. ft. With second- and third-row seats folded: 122.9 cu. ft.

		2WD	4WD
Payload ²	5.3L	1,834 lbs.	1,746 lbs.
	6.2L	1,671 lbs.	1,616 lbs.
	3.0L	1,717 lbs.	1,625 lbs.
Maximum trailering weight ratings ³	5.3L	7,900 lbs.	7,700 lbs.
	5.3L with Max Trailering Package	8,400 lbs.	8,200 lbs.
	6.2L	7,800 lbs.	7,600 lbs.
	6.2L with Max Trailering Package	8,300 lbs.	8,100 lbs.
	3.0L	8,200 lbs.	8,000 lbs.
	3.0L with Max Trailering Package	8,200 lbs.	8,000 lbs.

EPA-ESTIMATED FUEL ECONOMY

5.3L V8 (L84) 2WD – regular fuel	15 MPG city/20 highway/17 combined
5.3L V8 (L84) 4WD – regular fuel	15 MPG city/20 highway/17 combined
5.3L V8 (L84/NSS ⁴) 2WD – regular fuel	15 MPG city/20 highway/17 combined
5.3L V8 (L84/NSS ⁴) 4WD – regular fuel	14 MPG city/19 highway/16 combined
6.2L V8 (L87) 2WD – premium fuel	14 MPG city/20 highway/16 combined
6.2L V8 (L87) 4WD – premium fuel	14 MPG city/19 highway/16 combined
6.2L V8 (L87/NSS ⁴) 2WD – premium fuel	14 MPG city/20 highway/16 combined
6.2L V8 (L87/NSS ⁴) 4WD – premium fuel	14 MPG city/19 highway/16 combined
3.0L 2WD	21 MPG city/28 highway/24 combined
3.0L 4WD	20 MPG city/26 highway/22 combined

DIMENSIONS

A – Wheelbase	120.9"
B – Length	210.7"
C – Height (2WD/4WD)	75.8"/75.9"

D – Front track	68.5"
E – Width	81.0"
Rear track	68.3"

Head room (first row/second row/third row)	42.3"/38.9"/38.2"
Head room with sunroof (first row/second row/third row)	40.4"/37.5"/38.2"
Leg room (first row/second row/third row)	44.5"/42.0"/34.9"
Shoulder room (first row/second row/third row)	66.0"/64.8"/62.7"
Hip room (first row/second row/third row)	61.5"/61.3"/49.4"

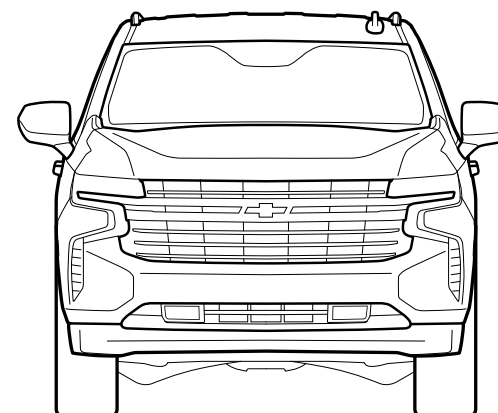
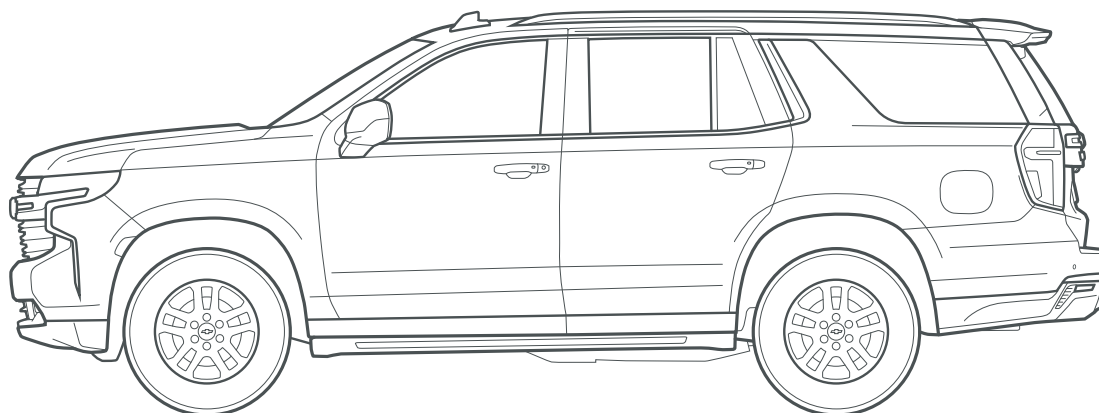

¹ Cargo and load capacity limited by weight and distribution. ² These maximum payload ratings are intended for comparison purposes only. Before you buy a vehicle or use it to haul people or cargo, carefully review the Vehicle Loading section of the Owner's Manual and check the carrying capacity of your specific vehicle on the label on the inside of the driver door jamb. ³ Maximum trailering ratings are intended for comparison purposes only. Before you buy a vehicle or use it for trailering, carefully review the Trailering section of the Owner's Manual. The trailering capacity of your specific vehicle may vary. The weight of passengers, cargo and options or accessories may reduce the amount you can trailer. ⁴ Most vehicles built between October 2021 and December 12, 2021, equipped with a V8 engine are not equipped with Automatic Stop/Start and its content. Contact a dealer for details on a specific vehicle. Vehicles not equipped with Automatic Stop/Start will be less fuel efficient.

ACCESSORIES



Roof Rack Cross Rail Package in Black
available from Chevrolet Accessories!



Premium All-Weather Floor Liners
in Jet Black with Chevrolet Script
available from Chevrolet Accessories!



Premium Carpeted Cargo Area Mat in
Jet Black with Integrated Cargo Bin
available from Chevrolet Accessories!



22" Multi-Spoke Black Aluminum
Wheels with Select Machining
available from Chevrolet Accessories!

IMPORTANT INFORMATION



Every step of the way.

You may be discovering Chevrolet through a personalized online shopping experience or enjoying every year of vehicle ownership. Either way, we're committed to providing the tools and programs you need to help you get the most out of your journey.

Build & Price >

Create your perfect Chevrolet from start to finish.

Chevy MyWay¹ >

Engage in a real-time virtual video experience with a Chevy product specialist.

Chevrolet Complete Care >

Enjoy an owner benefit program that provides excellent service and support from day one.

Discover My Chevrolet Rewards² >

Unlock a world of appreciation that's all about you and your Chevrolet. Start earning and redeeming today.

Chevy Truck Legends >

Honoring our dependable, long-lasting trucks and the people who keep them going strong.

Limited Warranty Coverage >

Discover all the ways Chevrolet is committed to providing an excellent ownership experience.



GM, the GM logo, Chevrolet, the Chevrolet logo, and the slogans, emblems, vehicle model names, vehicle body designs and other marks appearing in this brochure are the trademarks and/or service marks of General Motors, its subsidiaries, affiliates or licensors. ©2022 OnStar LLC. All rights reserved. Sirius, XM, SiriusXM and all related marks and logos are trademarks of Sirius XM Radio Inc. Apple CarPlay, iPhone, Siri and Apple Music are trademarks of Apple Inc., registered in the U.S. and other countries. The Bluetooth word mark is a registered trademark owned by Bluetooth SIG, Inc., and any use of such mark by Chevrolet is under license. Bose and Centerpoint are registered trademarks of the Bose Corp. Google, Android and Android Auto are trademarks of Google LLC.

©2022 General Motors. All rights reserved. April 2022

FIND NEW ROADS™

CHEVROLET.COM

¹ Chevy MyWay is available to anyone over 18 in the United States to access and experience via chevrolet.com/myway. ² Must be 18 years or older. Points may be earned and redeemed only at GM entities, My Chevrolet Rewards participating dealers or third party retailers in the United States (excluding Puerto Rico, the U.S. Virgin Islands or Guam). Points are not earned on taxes, fees or body shop repair orders and expire without further notice upon Member Account deactivation. Visit myChevroletrewards.com to view My GM Rewards Terms & Conditions.